RadioRA®



Wireless Central Lighting Control

Setup Guide

A Step-by-Step Guide for Programming and Operating a Complete Lutron RadioRA® Wireless Central Home Lighting Control System

Note: Please leave this manual with homeowner.

LUTRON®

Important Application Notes

1. It is recommended that only one GRAFIK Eye® Control Unit be wired to each GRAFIK Eye® Interface. Multiple GRAFIK Eye® Control Units may be wired (linked) to the same GRAFIK Eye® Interface, however, all GRAFIK Eye® Control Units on that link will respond in unison to the commands from the GRAFIK Eye® Interface. ALL GRAFIK Eye® Control Units wired to the same Interface will carry out ALL commands from the GRAFIK Eye® Interface (i.e. go to GRAFIK Eye® scene 3, Turn OFF, etc...). Interface commands cannot be sent to one individual GRAFIK Eye® Control Unit on a link of multiple GRAFIK Eye® Control Units.
 - This application may be desired if multiple GRAFIK Eye® Control Units are in the same room and it is intended that the same scene be selected on each GRAFIK Eye® Control Unit simultaneously.
 - Lutron does **not** recommend using one GRAFIK Eye® Interface to linked GRAFIK Eye® Control Units located in more than one room.
2. Scene 1 on a GRAFIK Eye® Control Unit is the default scene for ALL ON, SECURITY, and FLASH MODES. It is recommended scene 1 on GRAFIK Eye® Control Units be set to full intensity with a fade time of zero seconds.
3. Setting the light levels for GRAFIK Eye® scenes should be done prior to any operations in this Setup Guide.
4. A GRAFIK Eye® scene may be added to any RadioRA® Master Control button which has been previously programmed without altering that buttons existing programming.
5. See RadioRA® Application Note No.48 (P/N 366-730) for steps to activate GRAFIK Eye® scenes 5-16 from a RadioRA® Master Control.
6. For information on integrating your RadioRA® system with an astronomic timeclock, photocell, telephone interface, car visor control, shade motor control, etc... see the RadioRA® Application Notes on our web page at www.lutron.com/applicationnotes/index.html.
7. RadioRA® lighting control systems use radio frequency technology for communication. Currently, RadioRA® lighting control systems are available in two frequencies. To determine the frequency of a RadioRA® product, examine the model number on the product's unit label. The labels are located on the side of all "wallbox" products, and on the bottom of all "tabletop" products.

The second letter in all RadioRA® model numbers indicates the product's frequency. For example: RA-600LM is an "A" frequency product, whereas RB-600LM is a "B" frequency product.

Note: Do not mix RadioRA® "A" and "B" frequency products within the same system. Products with different frequencies **are not** compatible.

If you have any questions concerning the installation or operation of this product, please call the Lutron Technical Support Center at 1-800-523-9466.

Consumer Information



This symbol is intended to alert the user to the presence of important installation and operating instructions.

Danger

This RadioRA® system must not be used to control equipment, other than lighting, which is not visible from every master or local control location. It also must not be used to control equipment which could create hazardous situations such as entrapment if operated accidentally. Examples of equipment which must not be controlled by this RadioRA® system include (but are not limited to) motorized gates, garage doors, industrial doors, and microwave ovens, heating pads, etc. It is the installer's responsibility to ensure that the equipment, other than lighting, being controlled is visible from every master or local control location and that only suitable equipment is connected to this RadioRA® system.

FCC Information

NOTE: This equipment has been tested and found to comply with the limits for a Class B digital device, pursuant to part 15 of the FCC rules. These limits are designed to provide reasonable protection against harmful interference in a residential installation. This equipment generates, uses and can radiate radio frequency energy and, if not installed and used in accordance with the instructions, may cause harmful interference to radio or television reception, which can be determined by turning the equipment off and on, the user is encouraged to try to correct the interference by one or more of the following measures:

- Reorient or relocate the receiving antenna.
- Increase the separation between the equipment and receiver.
- Connect the equipment into an outlet on a circuit different from that to which the receiver is connected.
- Consult the dealer or an experienced radio/TV technician for help.

Caution: Changes or modifications not expressly approved by Lutron Electronics Co. could void the user's authority to operate this equipment.

Table of Contents

Section 1 - Start-Up

Activating Your System

Activating Repeaters	1-1
Activating Controls	1-3

Programming Preparations

Filling out the System Programming Worksheet	1-6
Assigning a Column of Buttons as ROOMS or SCENES	1-7

ROOM Button Programming

Assigning Dimmers, Switches or GRAFIK Eye® Control Units to ROOM Buttons	1-9
Setting Light Levels/GRAFIK Eye® Scene Selection for ROOM Buttons	1-11

SCENE Button Programming

Assigning Dimmers, Switches or GRAFIK Eye® Control Units to SCENE Buttons	1-13
Setting Light Levels/GRAFIK Eye® Scene Selection for SCENE Buttons	1-15

Section 2 - Advanced Features

Advanced Programming

Programming the ALL ON Button	2-1
Programming the ALL OFF Button	2-3
Copying Button Programming	2-5
Erasing Button Programming	2-7

Section 3 - Expanding Your System

Adding Basic System Components

Adding an Auxiliary Repeater	3-1
Adding Controls	3-3

Adding a Switch Closure Interface

Activating a Switch Closure Interface	3-5
Assigning Dimmers, Switches or GRAFIK Eye® Control Units to Input Channels	3-7
Setting Light Levels/GRAFIK Eye® Scene Selection for Input Channels	3-10

Section 4 - Troubleshooting

<i>Troubleshooting Guide</i>	4-1
------------------------------------	-----

Diagnostic Tools

BEEP Mode	4-3
FLASH Mode	4-4

Returning Components to Default Factory Settings

Master Controls	4-5
Switch Closure Interface	4-6
Dimmers	4-7
Switches	4-8
GRAFIK Eye® Interface	4-9
Repeaters	4-10

Section 5 - Miscellaneous

<i>Using RadioRA® Master Controls with Raise/Lower</i>	5-1
<i>Programming Worksheet</i>	5-2

Activating Your System

Activating Repeaters



Repeaters must be in their permanent location and all controls must be operating (dimmers and switches must be wired to a light) in order to be activated.

Important Notes:

1. If your system has only one Repeater, it must be assigned as a Main Repeater.
2. If your system has more than one Repeater, only **one** can be assigned as a Main Repeater.
3. If an LED turns orange while activating your system, a system error occurred, consult the Troubleshooting Guide.

Read each Step completely before starting.

Step 1 Assign a Main Repeater

Any Repeater in the system can be the Main Repeater.

Note: The green AUXILIARY LED will initially be ON on all Repeaters.

Press and hold the MAIN button until the green MAIN LED turns ON (approximately 3 seconds).

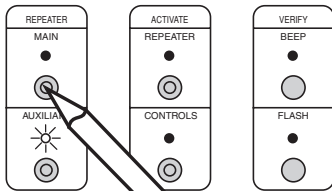

Green MAIN LED is ON.

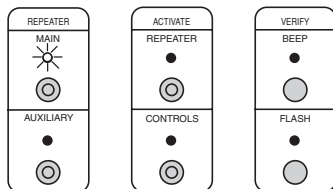

Step 2 Activate the Main Repeater

Press and hold the ACTIVATE REPEATER button until the green ACTIVATE REPEATER LED begins to flash (approximately 3 seconds).

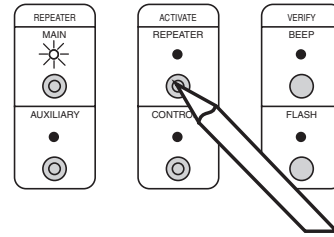

Green ACTIVATE REPEATER LED will stay ON when the Repeater has been activated.

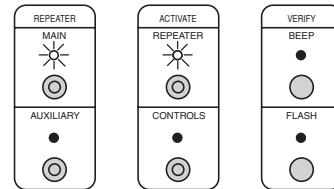

If the ACTIVATE REPEATER LED turns orange, consult the Troubleshooting Guide, Section I or II.

- If you have only one Repeater proceed to Step 4.

Activating Your System

Step 3 Activate each Auxiliary Repeater

Note: All remaining Repeaters must be Auxiliary Repeaters (up to 3).

Press and hold the ACTIVATE REPEATER button until the green ACTIVATE REPEATER LED begins to flash (approximately 3 seconds).

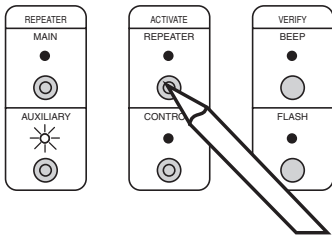

Green ACTIVATE REPEATER LED will stay ON when Repeater has been activated.

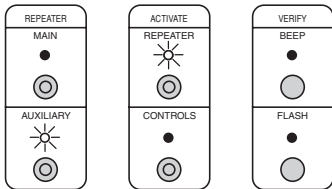

? If the ACTIVATE REPEATER LED turns orange, consult the Troubleshooting Guide, Section I, II or III.

- Repeat Step 3 to activate any remaining Auxiliary Repeaters.
- Proceed to Step 4 when all Repeaters have been activated.

Step 4 Complete Repeater activation

Press and hold the ACTIVATE REPEATER button on any Repeater until the green ACTIVATE REPEATER LED turns OFF (approximately 3 seconds).

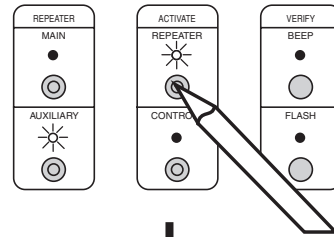

The green ACTIVATE REPEATER LED on **ALL** Repeaters will turn OFF. The MAIN or AUXILIARY LED will remain ON.

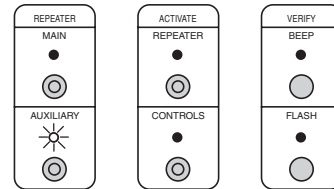

- Repeater activation is now complete.
- Proceed to Activate Controls on page 1-3.

Activating Your System

Activating Controls



Master Controls, Dimmers, Switches, and GRAFIK Eye® Control Units may be activated in any order.

Step 1 Begin Control activation

Press and hold the ACTIVATE CONTROLS button on **any** Repeater until the green ACTIVATE CONTROLS LED turns ON (approximately 3 seconds).

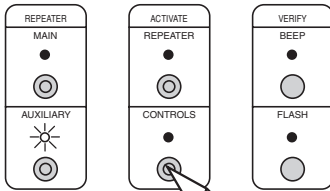

The green ACTIVATE CONTROLS LED on **ALL** Repeaters will turn ON.

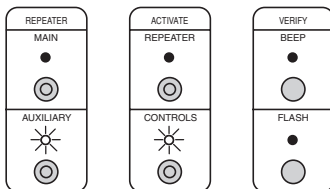

If the Activate Controls LED fails to turn ON, consult the Troubleshooting Guide, Section IV.

Step 2 Activate a Master Control

Go to any Master Control.

Press any button.

- All LEDs will flutter, then
- Top and bottom row will flash alternately

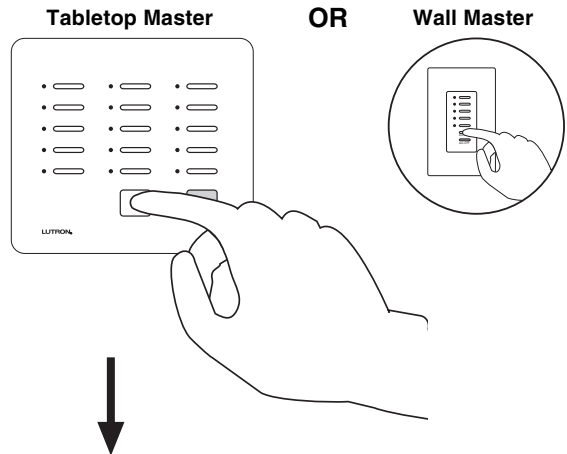

Middle row of LEDs will turn ON when Master Control has been activated.

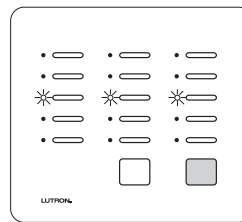

If a Master Control fails to respond as described above, consult the Troubleshooting Guide, Section VI or VII.

- Repeat Step 2 to activate any remaining Master Controls.



Activate one Master Control at a time. Wait for the middle row of LEDs to turn ON before activating any remaining Master Controls.

- Proceed to Step 3 when all Master Controls have been activated.

Activating Your System

Step 3 Activate a Dimmer, Switch or GRAFIK Eye® Control Unit

Go to any Dimmer, Switch or GRAFIK Eye® Control Unit. Turn the Dimmer or Switch ON or OFF by pressing the tapswitch. On a GRAFIK Eye® Control Unit, change the selected scene by pressing a scene button.

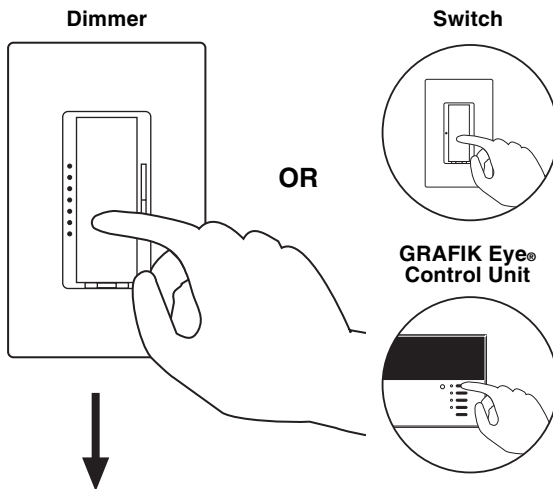

The light(s) that the Dimmer, Switch or GRAFIK Eye® Control Unit operate will turn ON and OFF a few times when it has been activated.

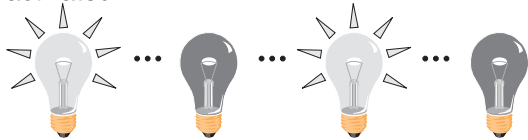

If a Dimmer, Switch or GRAFIK Eye® Control Unit fails to respond as described above, consult the Troubleshooting Guide, Section V.

- Repeat Step 3 to activate any remaining Dimmers, Switches or GRAFIK Eye® Control Units.



Activate one Dimmer, Switch or GRAFIK Eye® Control Unit at a time. Wait for the control to flash its light(s) before activating any remaining controls.

- Proceed to Step 4 when all Dimmers, Switches or GRAFIK Eye® Control Units have been activated.

Step 4 Complete Control activation

Press and hold the ACTIVATE CONTROLS button on any Repeater until the green ACTIVATE CONTROLS LED turns OFF (approximately 3 seconds).

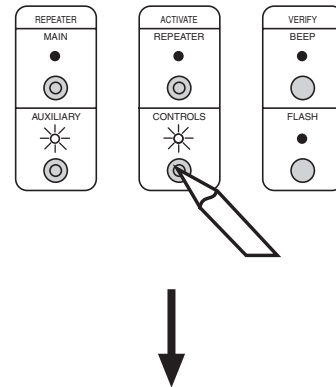

The green ACTIVATE CONTROLS LED on **ALL** Repeaters will turn OFF. The MAIN or AUXILIARY LED will remain on.

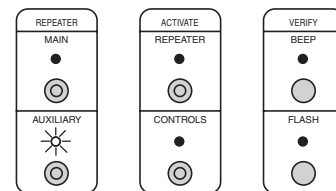

- Continued on next page.

Activating Your System

Step 5 Verify that all Controls have been activated

Press and hold the FLASH button on any Repeater until the green FLASH LED turns ON (approximately 3 seconds).

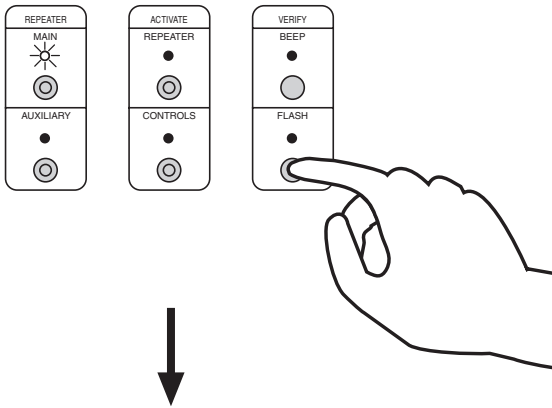

Green FLASH LED on all Repeaters will turn ON.

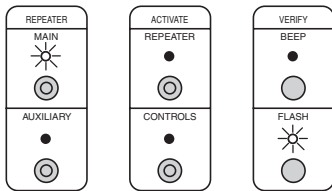

Master Controls, if activated, will flash all their LEDs. Make note of any Master Controls which are not activated.

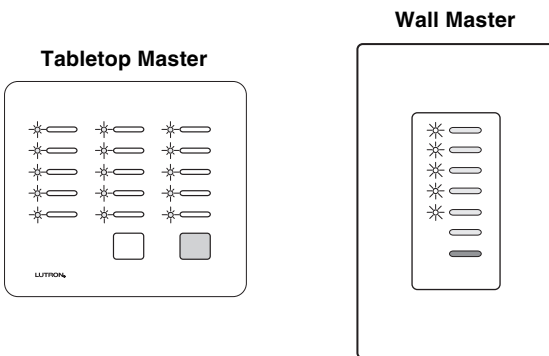

Dimmers, Switches, and GRAFIK Eye® Control Units, if activated, will flash the light(s) they control. Make note of any Dimmers, Switches or GRAFIK Eye® Control Units which are not activated.

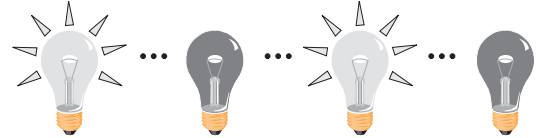

After verifying that all Master Controls, Dimmers, Switches, and GRAFIK Eye® Control Units are activated, press and hold the FLASH button on any Repeater until the green FLASH LED turns OFF (approximately 3 seconds).

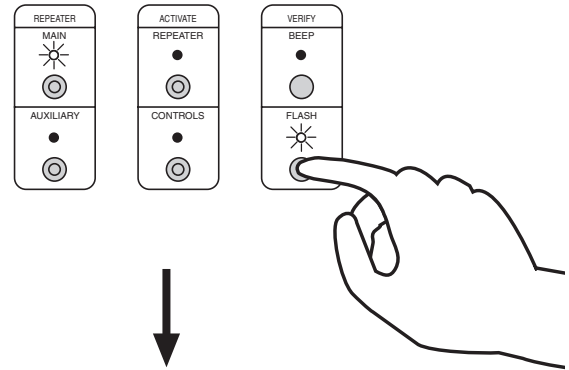

Green FLASH LED on all Repeaters will turn OFF.

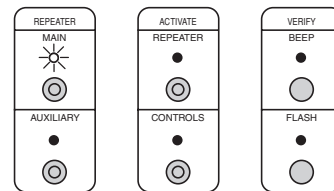

If any Master Control, Dimmer, Switch or GRAFIK Eye® Control Unit has not been activated, repeat Steps 1 through 5, starting on page 1-3.

- **Master Controls, Dimmers, Switches, and GRAFIK Eye® Control Units are now activated.**
- **Proceed to Programming Preparations on page 1-6.**

Programming Preparations

System Programming Worksheet

After the System has been activated, the Master Controls (M.C.) should be programmed so that a light or a group of lights can be controlled by one or more Master buttons. Prior to programming your system, complete the RadioRA® System Programming Worksheet (page 5-2).

Step 1 Record all Dimmer, Switch, and GRAFIK Eye® Control Unit locations along the top of the worksheet

(Accessory Dimmers and Accessory Switches do not need to be recorded.)

M.C. Type: 15 Button Tabletop 1 2 3 4 5

M.C. Location: Master BR

Button #	Label	Controls	Master BR Dimmer	Front Hall Dimmer	Rear Hall Dimmer
1					
2					
3					
4					

Step 2 Select a Master Control

Start with any Master Control and write down its type and location.

M.C. Type: 15 Button Tabletop 1 2 3 4 5

M.C. Location: Master BR

Button #	Label	Controls	Master BR Dimmer	Front Hall Dimmer	Rear Hall Dimmer	Den GRAFIK Eye	Front Porch Switch
1							
2							
3							
4							

Step 3 Record button names

Write name you have chosen for each button under the *Label* column of the worksheet. Refer to label sheets for names.

M.C. Type: 15 Button Tabletop 1 2 3 4 5

M.C. Location: Master BR

Button #	Label	Controls	Master BR Dimmer	Front Hall Dimmer	Rear Hall Dimmer	Den GRAFIK Eye	Front Porch Switch
1	<u>M Bedrm</u>						
2	<u>Hall</u>						
3	<u>Den</u>						
4							

Step 4 Select Dimmers, Switches or GRAFIK Eye® Control Units

Select which Dimmers, Switches or GRAFIK Eye® Control Units will be controlled by each Master Control button by going across the worksheet and placing a check in the corresponding box(es).

M.C. Type: 15 Button Tabletop 1 2 3 4 5

M.C. Location: Master BR

Button #	Label	Controls	Master BR Dimmer	Front Hall Dimmer	Rear Hall Dimmer	Den GRAFIK Eye	Front Porch Switch
1	<u>M Bedrm</u>		✓				
2	<u>Hall</u>			✓	✓		
3	<u>Den</u>					✓	
4	<u>Outside</u>						✓

Step 5 Label Master Control buttons

Apply one of the supplied labels in the space under each button.

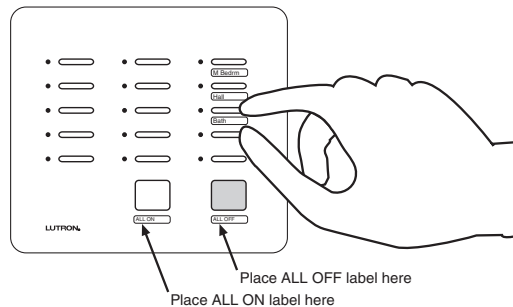

- Repeat Steps 1 through 5, for all Master Controls in your system.
- Proceed to Assigning a Column of Buttons as ROOMS or SCENES on page 1-7.

Programming Preparations

Assigning a Column of Buttons as ROOMS or SCENES



Each column of buttons on a Master Control can be programmed to be either ROOM or SCENE buttons.

What is a ROOM button?

ROOM buttons can be used to turn a light or a group of lights ON or OFF. Pressing a ROOM button once will turn ON all Dimmers or Switches assigned to that button to their pre-selected light level. Pressing the same ROOM button again will turn OFF all Dimmers or Switches assigned to that button. A ROOM LED will be ON if any Dimmer or Switch assigned to that button is ON, regardless of its light level.

What is a SCENE button?

SCENE buttons can be used to direct any combination of Dimmers and/or Switches to a pre-selected state or light level. Pressing a SCENE button once will turn ON any Dimmers or Switches assigned to turn ON, and turn OFF any Dimmers or Switches assigned to turn OFF. Pressing the same SCENE button again will turn OFF all Dimmers or Switches assigned to that button. A SCENE LED on a Master Control will be ON if, and only if, that SCENE button was pressed on that Master Control. An example of a SCENE application could be a button called "BEDTIME", which when pressed all interior lights would turn OFF and selected outside lights would turn ON.



All button columns are factory set as ROOM buttons.



Changing a column assignment from ROOM to SCENE (or vice versa) will delete all previous programming in that column of buttons.

Step 1 Begin ROOM/SCENE assignment

Simultaneously press and hold the 3rd, 5th, and ALL OFF buttons in the right most column until an LED in each column of the Master Control which you are programming begins to flash (approximately 3 seconds).

Note: On a 5 button Raise/Lower Wall Master, press and hold the 3rd, 5th, and Lower buttons.

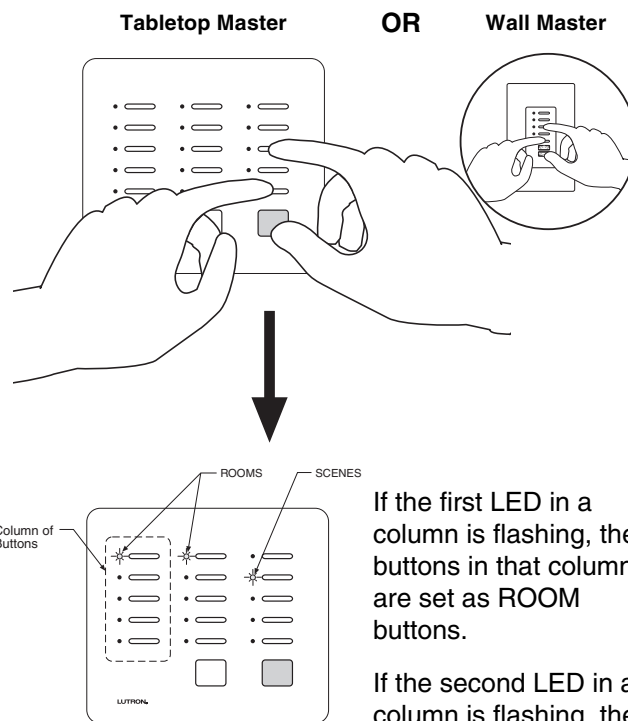

If the first LED in a column is flashing, the buttons in that column are set as ROOM buttons.

If the second LED in a column is flashing, the buttons in that column are set as SCENE buttons.

Step 2 Changing ROOM/SCENE assignments

Press the 1st button in a column to make that column a ROOM column, or press the 2nd button to make it a SCENE column.

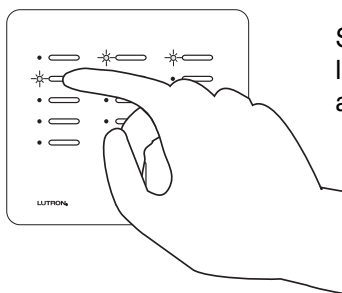

Shown: Setting left most column as SCENES.

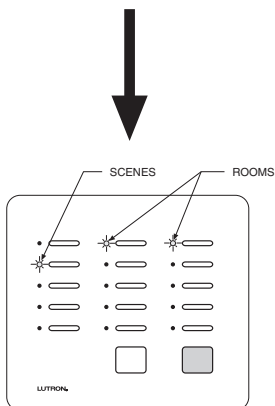

Step 3 Complete ROOM/SCENE assignment

Simultaneously press and hold the 3rd, 5th, and ALL OFF buttons in the right most column until the LEDs stop flashing (approximately 3 seconds).

Note: On a 5 button Raise/Lower Wall Master, press and hold the 3rd, 5th, and Lower buttons.

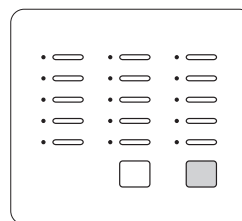
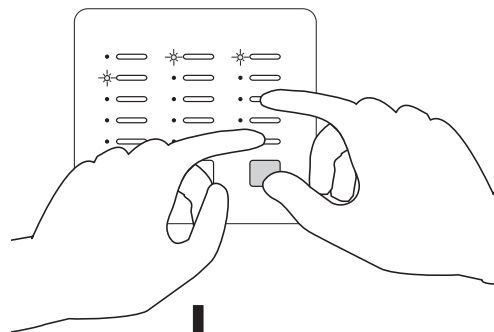

Step 4 Label columns

Apply the supplied ROOMS or SCENES labels to the space provided over each button column.

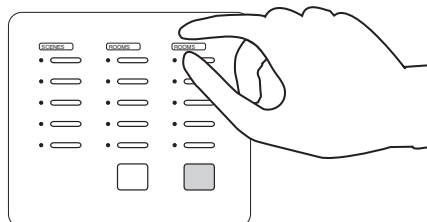

- Proceed to Assigning Dimmers, Switches or GRAFIK Eye® Control Units to ROOM Buttons on page 1-9.

ROOM Button Programming

Assigning Dimmers, Switches or GRAFIK Eye® Control Units to ROOM Buttons

NOTE: A column of buttons can also be assigned as SCENES (see page 1-7).

Step 1 Begin assigning Dimmers, Switches, or GRAFIK Eye® Control Units to ROOM buttons

Simultaneously press and hold the 2nd and 4th buttons in the right most column until the upper right LED begins to flash (approximately 3 seconds).

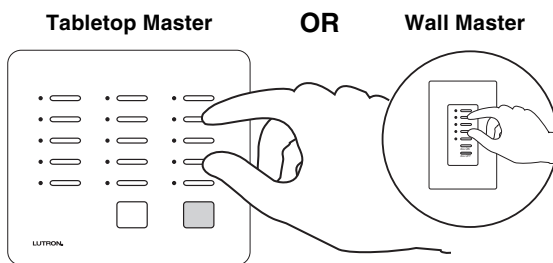

Upper right LED flashes.

Step 2 Select a ROOM Button

Press and release the ROOM button that you want to program. Its LED will begin to flash.

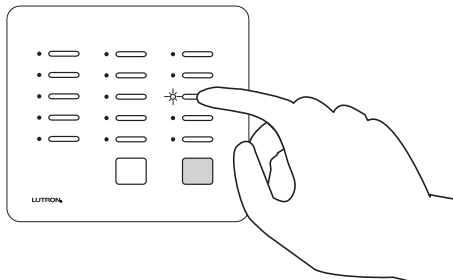

Step 3 Assign a Dimmer, Switch or GRAFIK Eye® Control Unit Control to the button

Notes:

- Multiple Dimmers, Switches or GRAFIK Eye® Control Units can be assigned to a single ROOM button.
- Controls must be assigned to a Master Control button while its LED is flashing.

Assign Dimmers or Switches to the Master Control button by turning the Controls ON.

Assign a GRAFIK Eye® Control Unit to the Master Control button by changing the selected GRAFIK Eye® scene.

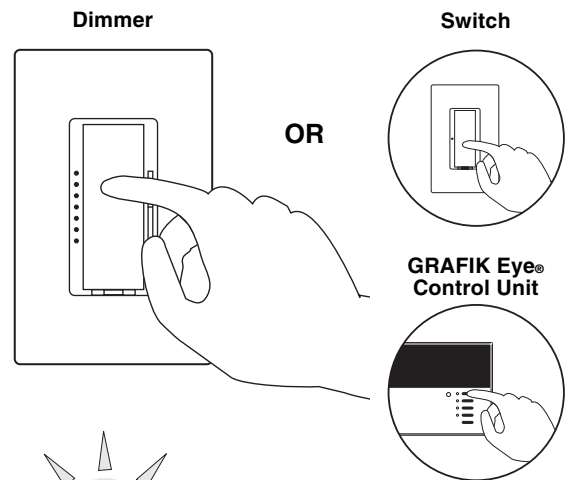

Note: GRAFIK Eye® Control Units will automatically turn on to scene 1 once assigned.



If you assign the wrong Dimmer, Switch or GRAFIK Eye® Control Unit to a Master Control button, turn the Dimmer, Switch or GRAFIK Eye® Control Unit OFF to unassign it.



ROOM Button Programming

Step 4 Select next ROOM button

To assign Dimmers, Switches or GRAFIK Eye® Control Units to another Master Control ROOM button, press and release that button. Its LED will begin to flash.

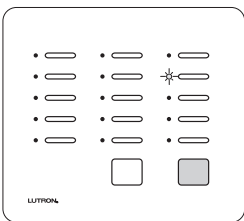
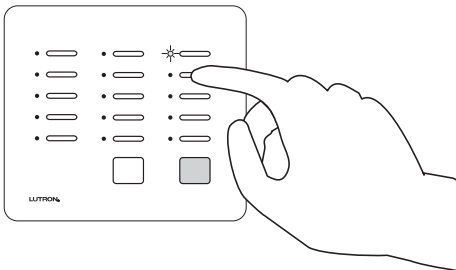

Perform Step 3 for this newly selected ROOM button.

- Proceed to Step 5 when all ROOM buttons on this Master Control have been programmed.

Step 5 Complete assigning Dimmers, Switches, and GRAFIK Eye® Control Units

Simultaneously press and hold the 2nd and 4th buttons in the right most column until all LEDs begin to flutter (approximately 3 seconds).

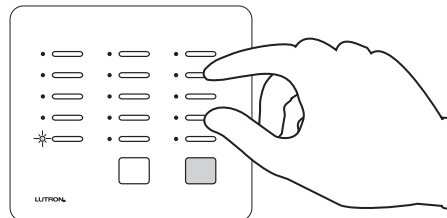

- Repeat Steps 1 through 5 to assign Dimmers, Switches or GRAFIK Eye® Control Units to ROOM buttons on any additional Master Controls.
- Pressing a newly programmed ROOM button at this point will turn assigned: Dimmers on to 100% light, Switches ON, and GRAFIK Eye® Control Units ON to scene 1.
- Proceed to Setting Light Levels/GRAFIK Eye® Scene Selection for ROOM Buttons on page 1-11.

ROOM Button Programming

Setting Light Levels/GRAFIK Eye® Scene Selection for ROOM Buttons

Note: Dimmers can be set to a variable light level. Switches must remain ON. GRAFIK Eye® Control Units can be set to any scene.

Step 1 Begin setting light levels/ selecting GRAFIK Eye® scenes

Simultaneously press and hold the 1st and 5th buttons in the right most column until the upper right LED begins to blink (approximately 3 seconds).

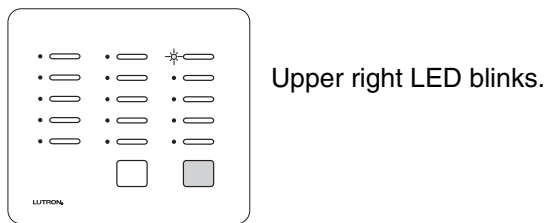
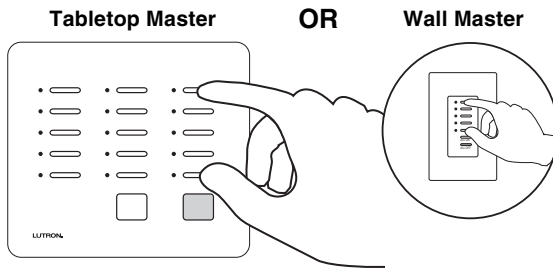

Step 2 Select a ROOM Button

Press and release the ROOM button that you want to program. Its LEDs will begin to blink.

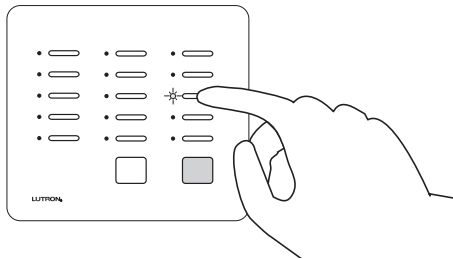

Dimmers, Switches, and GRAFIK Eye® Control Units that have been assigned to that button will turn ON. Devices not assigned to that button will turn OFF.

Step 3 Set light levels for Dimmers

Use the dimming rocker to adjust the light level of any Dimmer(s) assigned to that button. This is the light level that the Dimmers will turn ON to when the ROOM button is pressed ON.

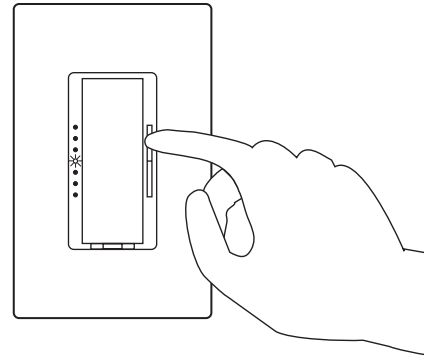

While setting light levels

- Dimmers assigned to a Master Control ROOM button cannot be turned OFF.
- Dimmers not assigned to a Master Control ROOM button cannot be turned ON.

Step 4 Select a GRAFIK Eye® scene

At the GRAFIK Eye® Control Unit, select one of the pre-programmed scenes (1 through 4) by turning that scene ON.

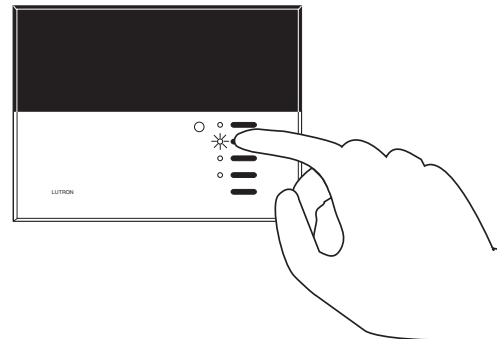

The GRAFIK Eye® Control Unit will turn ON to the scene selected in this step when the ROOM button is pressed ON. The last scene selected on the GRAFIK Eye® Control Unit will be the scene programmed to the ROOM button.

ROOM Button Programming

Step 5 Select the next ROOM button

To set the Dimmer light level/select a GRAFIK Eye® scene for another ROOM button, press that button. Its LED will begin to blink.

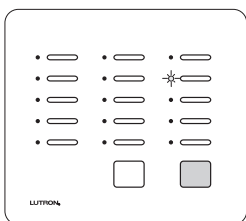
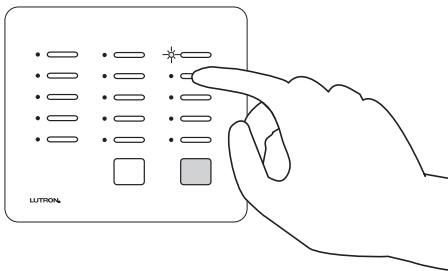

Perform Steps 3 and 4 (whichever apply) for this newly selected ROOM button.

- Proceed to Step 6 when all ROOM buttons on this Master Control have been programmed.

Step 6 Complete setting light levels/ selecting GRAFIK Eye® scenes

Simultaneously press and hold the 1st and 5th buttons in the right most column until all LEDs begin to flutter (approximately 3 seconds).

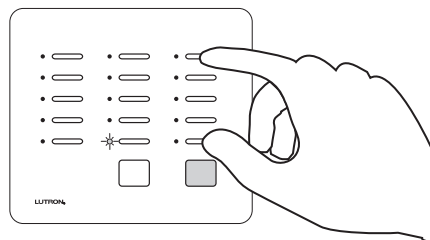

- Repeat Steps 1 through 6 to set the light levels/select GRAFIK Eye® scenes on any remaining Master Controls.
- To copy the button programming from one Master Control to another Master Control, see Copy Button Programming on page 2-5 of the Advance Features Section of this guide.

Congratulations. Your system is now programmed. Relax and enjoy your system.

SCENE Button Programming

Assigning Dimmers, Switches or GRAFIK Eye® Control Units to SCENE Buttons

Note: A column of buttons can also be assigned as ROOMS (see page 1-7).

Step 1 Begin assigning Dimmers, Switches or GRAFIK Eye® Control Units to SCENE buttons

Simultaneously press and hold the 2nd and 4th buttons in the right most column until the upper right LED begins to flash (approximately 3 seconds).

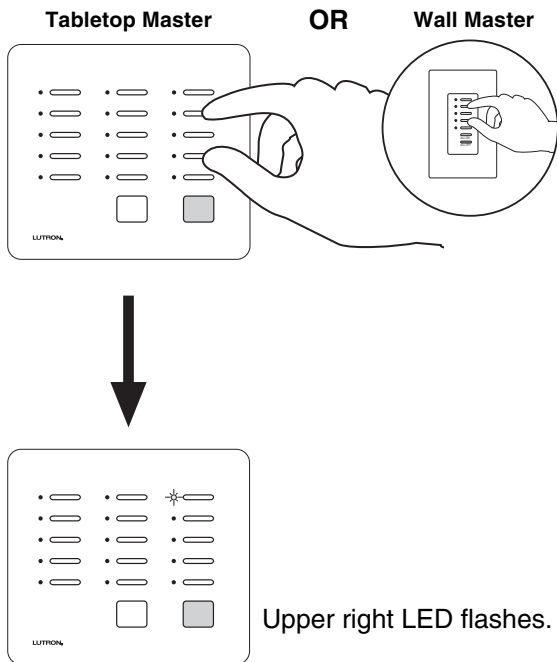

Step 2 Select a SCENE button

Press and release the SCENE button that you want to program. Its LED will begin to flash.

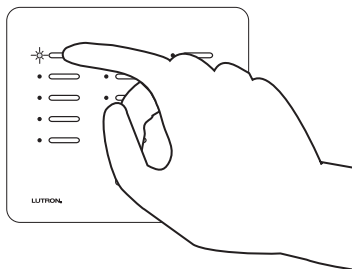

Step 3 Assign Dimmers, Switches or GRAFIK Eye® Control Units to the button

Note: Multiple Dimmers, Switches or GRAFIK Eye® Control Units can be assigned to a single SCENE button.



In this Step you must not only assign light controls which you want to turn ON when the button is pressed, you must also assign light controls which you want to turn OFF when the button is pressed.

Assign a Dimmer or Switch to the selected SCENE button by turning the Dimmer or Switch ON.

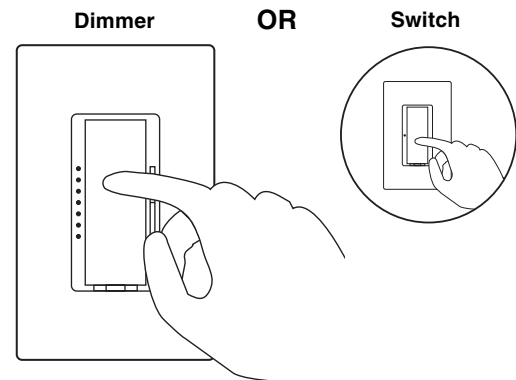

Assign a GRAFIK Eye® Control Unit to the selected SCENE button by changing the scene of the GRAFIK Eye® Control Unit.

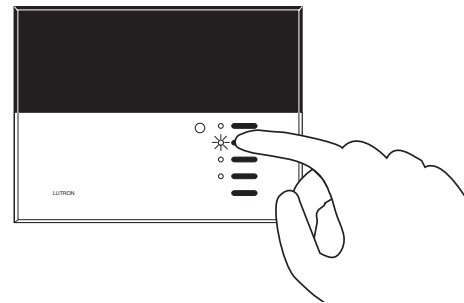

Note: GRAFIK Eye® Control Units will automatically turn ON to scene 1 once assigned.



If you assign the wrong Dimmer, Switch or GRAFIK Eye® Control Unit to a Master Control button, turn the Dimmer, Switch or GRAFIK Eye® Control Unit OFF to unassign it.



SCENE Button Programming

Step 4 Select next SCENE button

To assign Dimmers, Switches or GRAFIK Eye® Control Units to another Master Control SCENE button, press and release that button. Its LED will begin to flash.

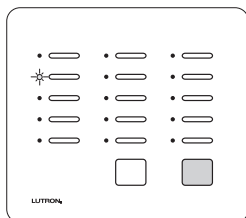
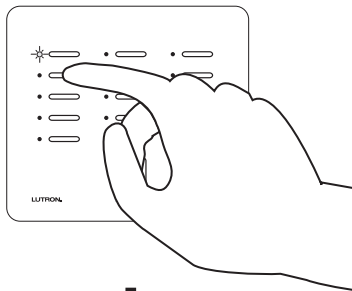

Perform Step 3 for this newly selected SCENE button.

- Proceed to Step 5 when all SCENE buttons on this Master Control have been programmed.

Step 5 Complete assigning Dimmers, Switches, and GRAFIK Eye® Control Units

Simultaneously press and hold the 2nd and 4th buttons in the right most column until all the LEDs begin to flutter (approximately 3 seconds).

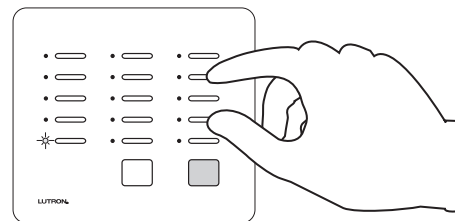

- Repeat Steps 1 through 5 to assign Dimmers, Switches or GRAFIK Eye® Control Units to SCENE buttons on any additional Master Controls.
- Pressing a newly programmed SCENE button at this point will turn assigned: Dimmers on to 50% light, Switches ON, and GRAFIK Eye® Control Units ON to scene 1.
- Proceed to Setting Light Levels/GRAFIK Eye® Scene Selection for SCENE Buttons on page 1-15.

SCENE Button Programming

Setting Light Levels/GRAFIK Eye® Scene Selection for SCENE Buttons

Note: Dimmers can be set to a variable light level or turned OFF. Switches can be turned ON or OFF. GRAFIK Eye® Control Units can be set to any scene or turned OFF.

Step 1 Begin setting light levels/ GRAFIK Eye® scene selection

Simultaneously press the 1st and 5th buttons in the right most column until the upper right LED begins to blink (approximately 3 seconds).

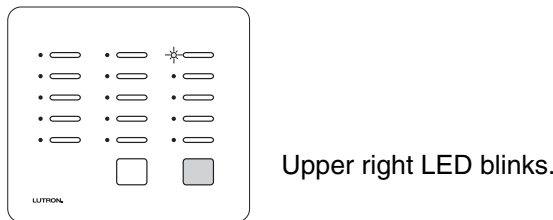
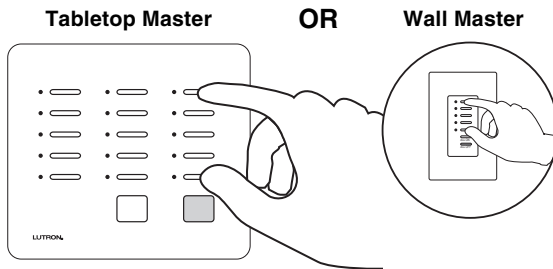

Step 2 Select a SCENE button

Press and release the SCENE button that you want to program. Its LED will begin to blink.

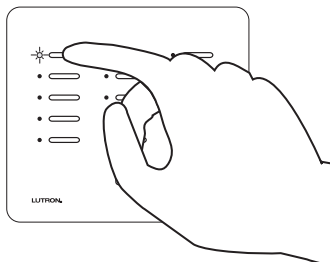

All devices assigned to that button will turn ON to: Dimmers 50% light level, Switches ON, and GRAFIK Eye® Control Units to scene 1. All devices not assigned to that button will turn OFF.

Step 3 Set light levels/select GRAFIK Eye® scenes

Go to any **assigned** Dimmer (which will be ON at 50%). Adjust this Dimmers programmed light level for the selected SCENE button using the dimming rocker, **or** turn the Dimmer OFF if it is to be turned OFF when this SCENE button is pressed.

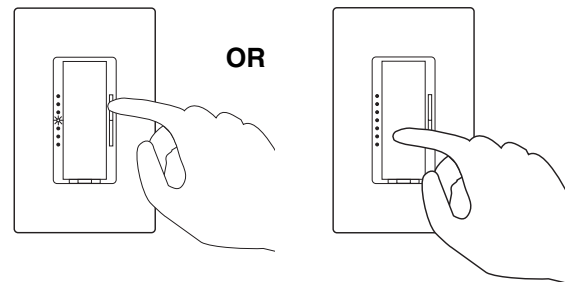

Go to any **assigned** Switch (which will be ON). Turn the Switch OFF if it is to be turned OFF when this SCENE button is pressed.

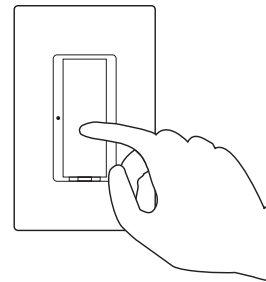

Go to any **assigned** GRAFIK Eye® Control Unit (which will be ON at scene 1). Select from pre-programmed scenes (1 through 4) by turning that scene ON **or** select OFF if it is to be turned OFF when this SCENE button is pressed.

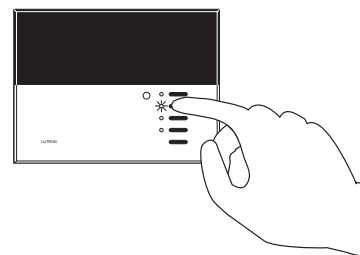

SCENE Button Programming

Step 4 Select next SCENE button

To set the light level for another Master Control SCENE button, press and release that button. Its LEDs will begin to blink.

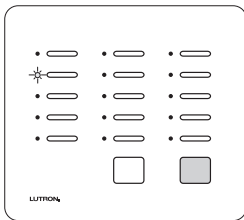
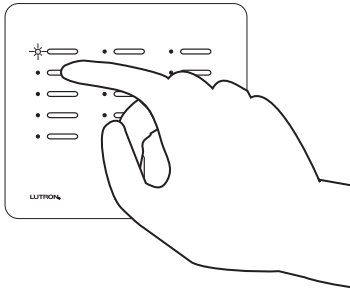

Perform Step 3 for this newly selected SCENE button.

- Proceed to Step 5 when all SCENE buttons on this Master Control have been programmed.

Step 5 Complete setting light levels/ selecting GRAFIK Eye® scenes

Simultaneously press the 1st and 5th buttons in the right most column until all LEDs begin to flutter (approximately 3 seconds).

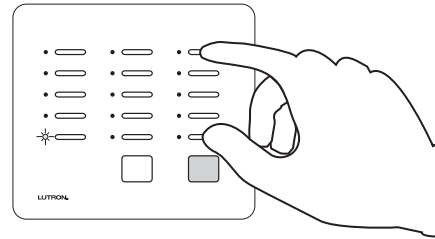

If at any point in this procedure you are unsure which Dimmers, Switches or GRAFIK Eye® Control Units are assigned to a Master Control SCENE button

- Press the button next to the blinking LED.
- The LED will begin to flash (slower) and all Dimmers, Switches, and GRAFIK Eye® Control Units assigned to that Master Control SCENE button will turn ON to full intensity.

Note: Dimmer, Switch or GRAFIK Eye® Control Unit assignments cannot be changed at this time. See page 1-13 to change control assignment.

- Press the same Master Control SCENE button again to continue setting light levels. The LED will begin to blink again (faster).

- Repeat Steps 1 through 5 to set the light levels/select GRAFIK Eye® scenes on any remaining Master Controls.
- To copy the button programming from one Master Control to another Master Control, see Copy Button Programming on page 2-5.

You may now operate your Master Control SCENE buttons

Advanced Programming

Programming the ALL ON Button

The ALL ON button on a RadioRA® Master Control will, by default, turn ON all Dimmers and Switches to full intensity, and GRAFIK Eye® Control Units to Scene 1 when pressed. The ALL ON button can be programmed to turn ON selected Dimmers (to full intensity), Switches, or GRAFIK Eye Control Units (to Scene 1).

 These programming steps only apply to Master Controls equipped with an ALL ON button.

Step 1 Begin the ALL ON button programming

On the Master Control you want to program, simultaneously press and hold the 2nd and 4th buttons in the right most column until the upper right LED begins to flash (approximately 3 seconds).

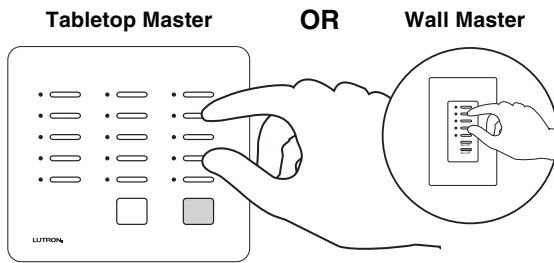

↓
Upper right LED flashes.

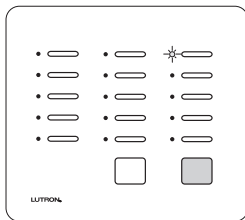

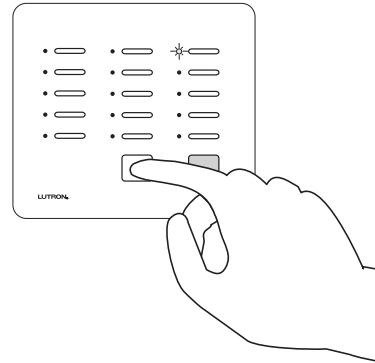

Step 2 Press the ALL ON button

Press the ALL ON button on the Master Control you are programming.

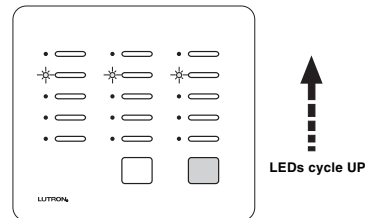

↓
The LEDs in all columns will simultaneously cycle from bottom to top.



 All Dimming/Switching Controls and GRAFIK Eye® Control Units will turn ON.

Step 3 Remove a Dimmer, Switch, or GRAFIK Eye® Control Unit from the ALL ON button

Turn OFF the Dimmer(s), Switch(es), or GRAFIK Eye® Control Unit(s) that you want removed from the ALL ON button programming.

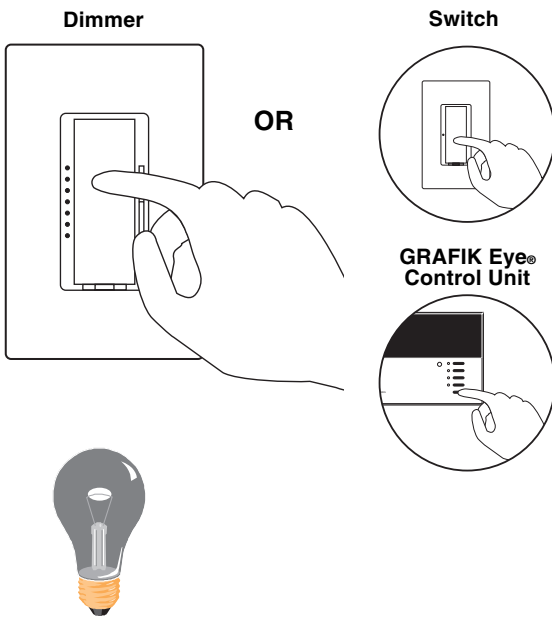

If you remove the wrong Dimmer, Switch, or GRAFIK Eye® Control Unit from the ALL ON button, turn the Dimmer, Switch, or GRAFIK Eye® Control Unit ON to reassign it.



Step 4 Complete the ALL ON button programming

Simultaneously press and hold the 2nd and 4th buttons in the right most column until all LEDs begin to flutter (approximately 3 seconds).

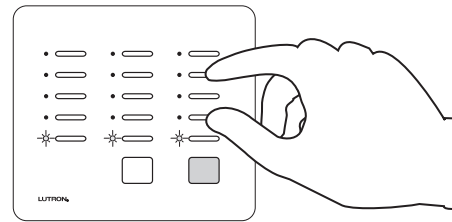

- Repeat Steps 1 through 4 to re-program the ALL ON button any additional Master Controls.

Advanced Programming

Programming the ALL OFF Button

The ALL OFF button on a RadioRA® Master Control will, by default, turn OFF all Dimmers, Switches, and GRAFIK Eye® Control Units when pressed. The ALL OFF button can be programmed to turn selected Dimmers, Switches, or GRAFIK Eye® Control Units OFF.

 These programming steps only apply to Master Controls equipped with an ALL OFF button.

Step 1 Begin the ALL OFF button programming

On the Master Control you want to program, simultaneously press and hold the 2nd and 4th buttons in the right most column until the upper right LED begins to flash (approximately 3 seconds).

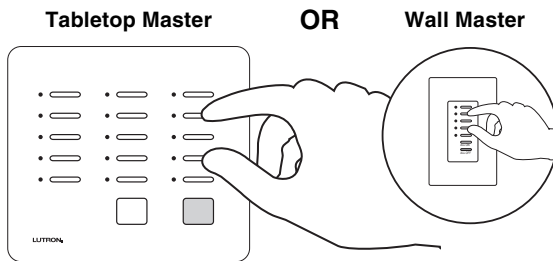

↓
Upper right LED flashes.

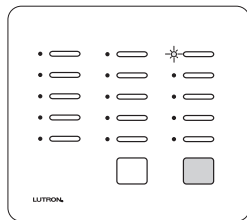

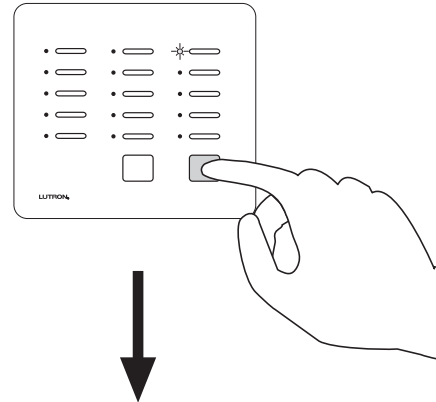

Step 2 Press the ALL OFF button

Press the ALL OFF button on the Master Control you are programming.

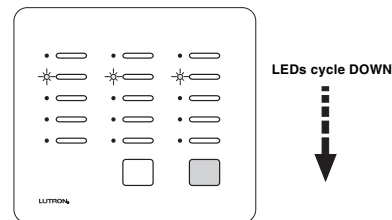

The LEDs in all columns will simultaneously cycle from top to bottom.



 All Dimming/Switching Controls and GRAFIK Eye® Control Units will turn ON.

Step 3 Remove a Dimmer, Switch, or GRAFIK Eye® Control Unit from the ALL OFF button

Turn OFF the Dimmer(s), Switch(es), or GRAFIK Eye® Control Unit(s) that you want removed from the ALL OFF button.

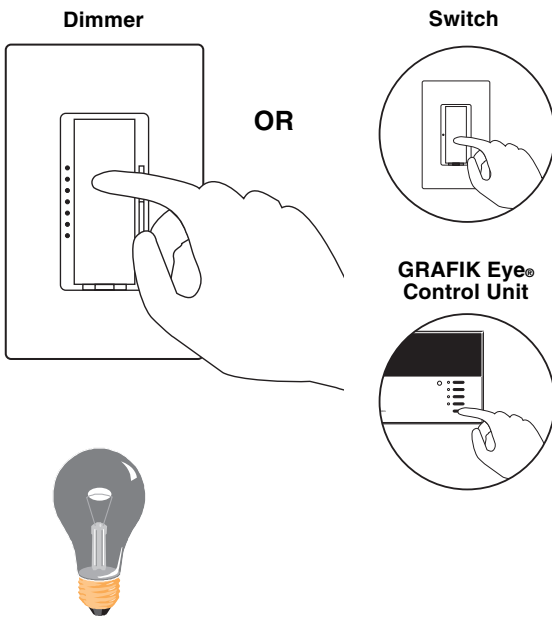

If you remove the wrong Dimmer, Switch, or GRAFIK Eye® Control Unit from the ALL OFF button, turn the Dimmer, Switch, or GRAFIK Eye® Control Unit ON to reassign it.



Step 4 Complete the ALL OFF button programming

Simultaneously press and hold the 2nd and 4th buttons in the right most column until all the LEDs begin to flutter (approximately 3 seconds).

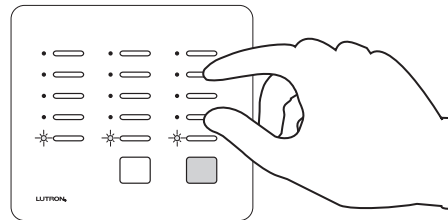

- Repeat Steps 1 through 4 to re-program the ALL OFF button any additional Master Controls.

Copying Button Programming

If you have more than one Master Control in your system, you can copy the button programming from a previously programmed Master Control button to an un-programmed Master Control button so that both buttons function identically.

Step 1 Begin Copying Button Programming

On the Master Control you want to program, simultaneously press and hold the 1st and 5th buttons in the right most column until the upper right LED begins to blink (approximately 3 seconds).

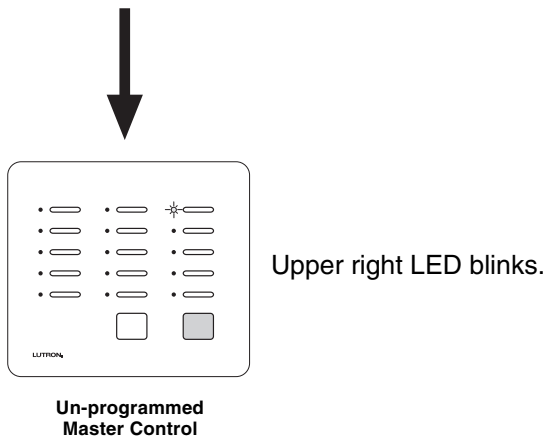
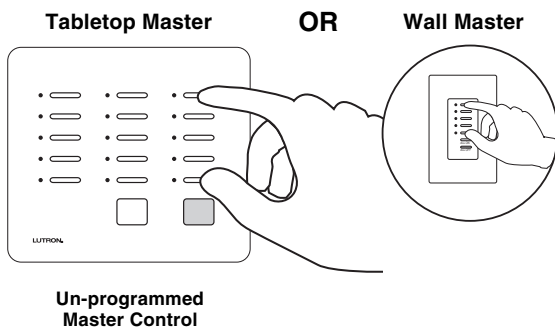

Note: LEDs on all other Master Controls will flash.

Step 2 Select the button you want to program

Press and release the button you want to program. Its LED will begin to blink.

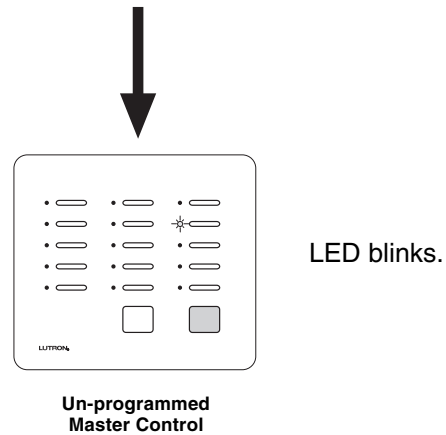
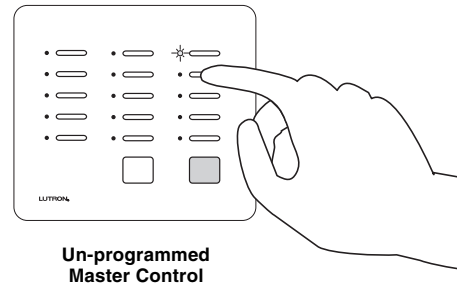

 The programming from a ROOM button cannot be copied to a SCENE button, or vice versa.

Step 3 Select the button you want to copy

On a previously programmed Master Control, press the programmed button that you want to copy until its LED turns OFF (approximately 3 seconds).

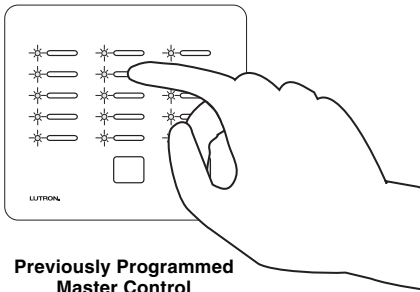

Previously Programmed Master Control

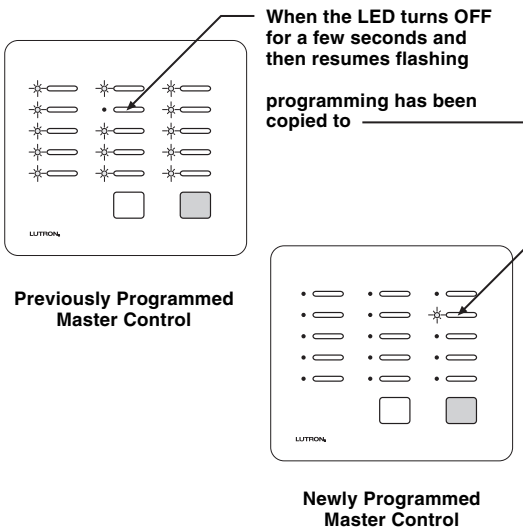

- Repeat Steps 2 and 3 for all Master Control buttons that you want to copy programming to.

Step 4 Complete Copy Button Programming

Simultaneously press and hold the 1st and 5th buttons in the right most column until all LEDs begin to flutter (approximately 3 seconds).

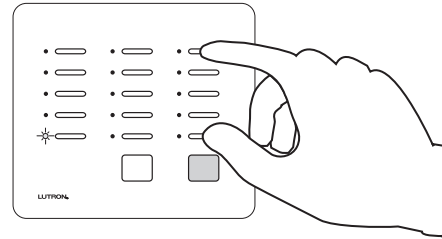

Newly Programmed Master Control

- Repeat Steps 1 through 4 to copy button programming on any remaining unprogrammed Master Controls.

Erasing Button Programming

Erasing Button Programming will remove all Dimming or Switching Controls assigned to a Master Control button and erase that button's programming.

Step 1 Begin Erasing Button Programming

Simultaneously press the 2nd and 4th buttons in the right most column until the upper right LED begins to flash (approximately 3 seconds).

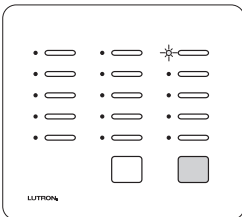
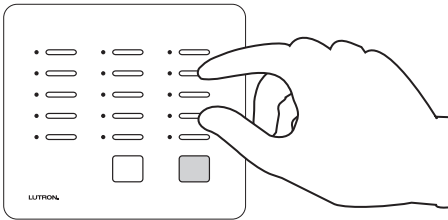

Upper right LED flashes.

Step 2 Select button to erase

Press and hold the button you wish to erase until its LED begins to flutter (approximately 3 seconds).

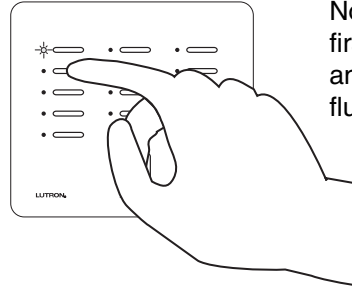

Note: The LED will first flash (slower) and then begin to flutter (faster).

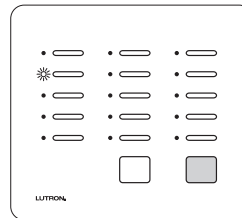

LED will flutter for only 3 seconds.

Step 3 Erase button

While the LED is fluttering, press the ALL OFF or Lower button in the right most column.

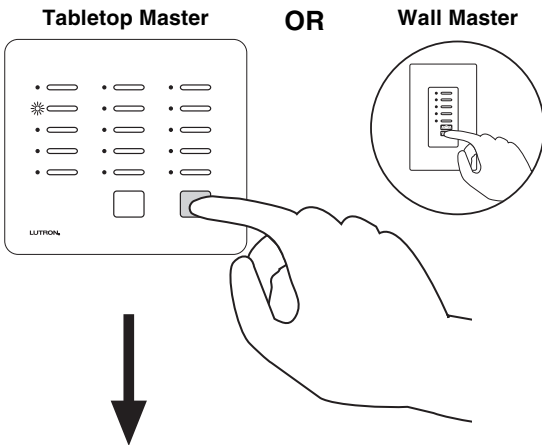

The LED will stop fluttering and begin to flash. All Dimmers and/or Switches will turn OFF, and programming is now erased from that Master Control button.

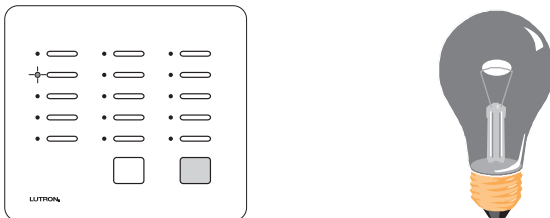

- Repeat Steps 2 and 3 for all Master Control buttons with programming that you want to erase.

Step 4 Complete Erasing Button Programming

Simultaneously press the 2nd and 4th buttons in the right most column until all LEDs begin to flutter (approximately 3 seconds).

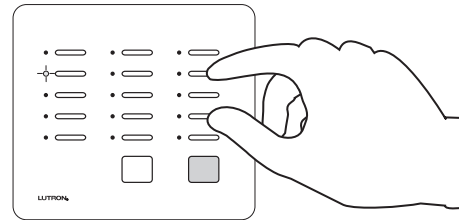

Adding Basic System Components

Adding an Auxiliary Repeater

Auxiliary Repeaters (up to a maximum of 3) can be added to a system to increase range and improve reliability.



Ensure all system devices are powered up and operating prior to adding any Auxiliary Repeaters.

Step 1 Begin Auxiliary Repeater Activation

Press and hold the ACTIVATE REPEATER button on any previously activated Repeater until the green ACTIVATE REPEATER LED turns ON (approximately 3 seconds).

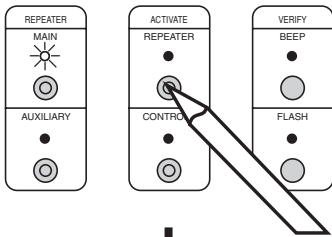

Green Activate Repeater LED will turn ON on all existing system Repeaters.

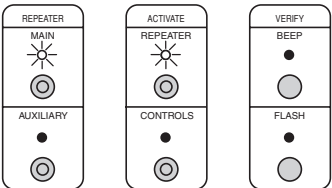

If the ACTIVATE REPEATER LED turns orange, consult the Troubleshooting Guide, Sections I.

Step 2 Activate Auxiliary Repeater

Press and hold the ACTIVATE REPEATER button on the new Auxiliary Repeater until the green ACTIVATE REPEATER LED begins to flash (approximately 3 seconds).

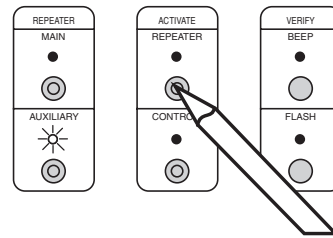

Green LED will stay ON when Repeater has been activated.

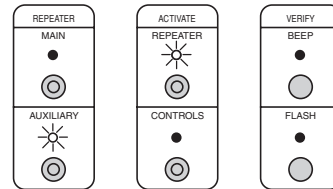

If the ACTIVATE REPEATER LED turns orange, consult the Troubleshooting Guide, Section I, II or III.

Adding Basic System Components

Step 3 Complete Repeater activation

Press and hold the ACTIVATE REPEATER button on any Repeater until the green ACTIVATE REPEATER LED turns OFF (approximately 3 seconds).

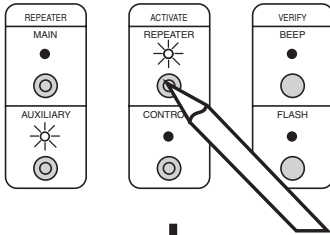

The green ACTIVATE REPEATER LED on **ALL** Repeaters will turn OFF. The MAIN or AUXILIARY green LED will remain ON.

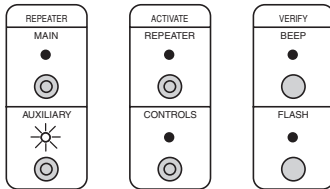

- Repeaters are now activated.

Adding Basic System Components

Adding Controls

Master Controls may be added to your system up to a maximum of 12. Dimmers, Switches, and GRAFIK Eye® Control Units may be added up to a maximum of 32.

Step 1 Begin control activation

Press and hold the ACTIVATE CONTROLS button on **any** Repeater until the green ACTIVATE CONTROLS LED turns ON (approximately 3 seconds).

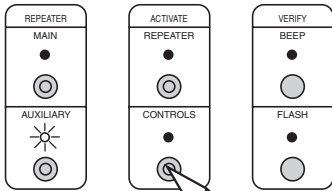

The green ACTIVATE CONTROLS LED on **ALL** Repeaters will turn ON.

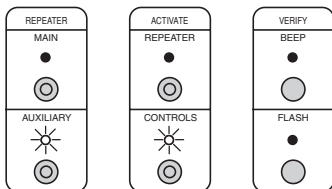

If the Activate Controls LED fails to turn ON, consult the Troubleshooting Guide, Section IV.

Step 2 Activate Controls

To add a Master Control

Go to the new Master Control.

Note: All LEDs will be OFF prior to activation.

Press any button.

- All LEDs will flutter, then
- Top and bottom row will flash alternately

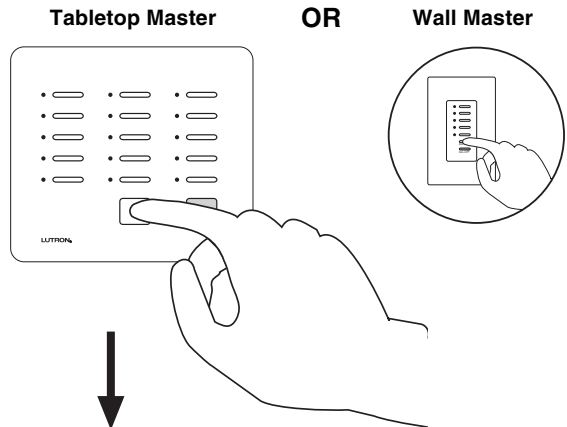

Middle row of LEDs will turn ON when the Master Control has been activated.

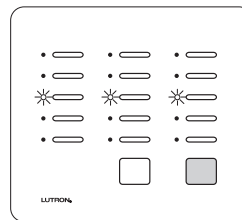

If a Master Control fails to respond as described above, consult the Troubleshooting Guide, Section VI or VII.

Repeat the above Step to activate any remaining Master Controls



Activate one Master Control at a time. Wait for the middle row of LEDs to turn ON before activating any remaining Master Controls.

Adding Basic System Components

To add a Dimmer, Switch or GRAFIK Eye® Control Unit

Go to the new Dimmer, Switch or GRAFIK Eye® Control Unit.

Turn the Dimmer or Switch ON or OFF by pressing the tapswitch. Change the selected scene on the GRAFIK Eye® Control Unit by pressing any of the preset buttons.

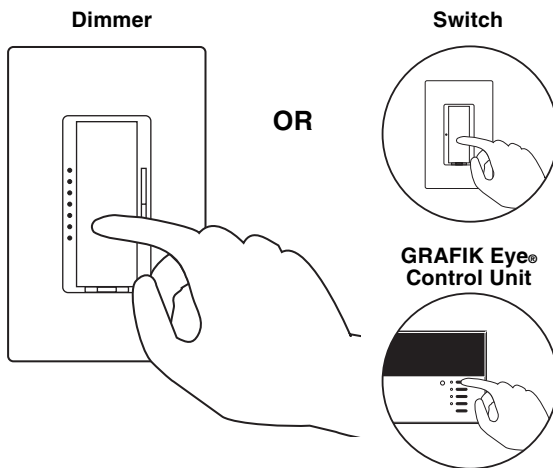

The lights that the Dimmer, Switch or GRAFIK Eye® Control Unit controls will turn ON and OFF a few times when it has been activated.

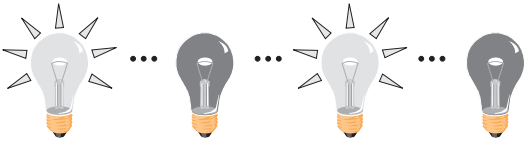

If a Dimmer, Switch or GRAFIK Eye® Control Unit fails to respond as described above, consult the Troubleshooting Guide, Sections V.

Repeat the above Step to activate any remaining Dimmers, Switches or GRAFIK Eye® Control Units



Activate one Dimmer, Switch or GRAFIK Eye® Control Unit at a time. Wait for the Dimmer, Switch or GRAFIK Eye® Control Unit to flash its light(s) before activating any remaining Dimmers, Switches or GRAFIK Eye® Control Units.

Step 3 Complete control activation

Press and hold the ACTIVATE CONTROLS button on any Repeater until the green ACTIVATE CONTROLS LED turns OFF (approximately 3 seconds).

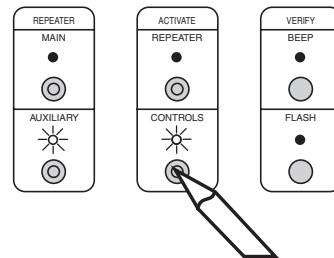

The green ACTIVATE CONTROLS LED on **ALL** Repeaters will turn OFF. The MAIN or AUXILIARY green LED will remain on.

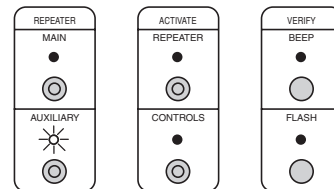

- Controls are now activated.
- If you want to Verify that all new Controls have been activated, see Flash Mode in the Troubleshooting Section on page 4-4.
- For programming instructions, see Assigning a Column of buttons as ROOMS or SCENES on page 1-7.

Adding a Switch Closure Interface

Activating a Switch Closure Interface

The Switch Closure Interface is a special type of Master Control. Therefore, the System can have a maximum of 12 Master Controls plus a Switch Closure Interface. For every 1 Master Control NOT used, 1 Switch Closure Interface may be used in its place.



The Switch Closure Interface has a 15 second delay after applying power. During this time the Power LED will blink. When the Power LED stays ON, the unit is ready for operation.

Step 1 Begin Switch Closure Interface activation

Press and hold the ACTIVATE CONTROLS button on **any** Repeater until the green ACTIVATE CONTROLS LED turns ON (approximately 3 seconds).

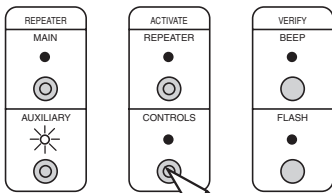

The green ACTIVATE CONTROLS LED on **ALL** Repeaters will turn ON.

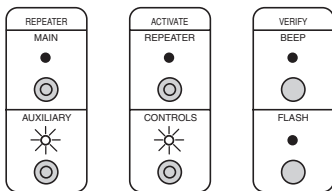

Step 2 Activate Switch Closure Interface

Press any button.

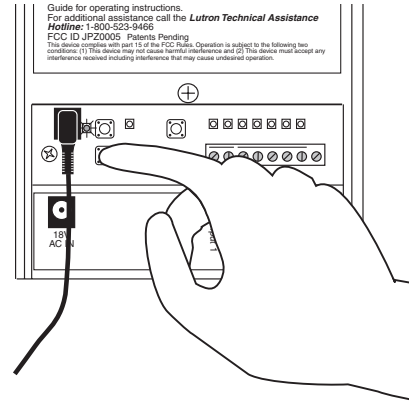

- All input LEDs will flutter, then
- The Flash LED and Input 1 LED will alternately flash.

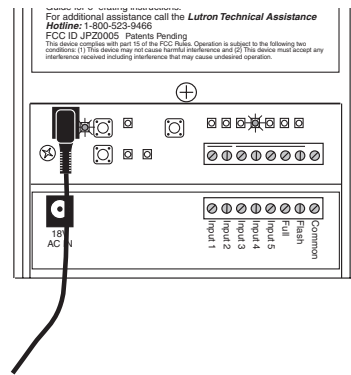

Input 4 LED will remain ON when the Switch Closure Interface has been activated.



If a Switch Closure Interface fails to respond as described above, consult the Troubleshooting Guide, Section XI.

Adding a Switch Closure Interface

Step 3 Complete Switch Closure Interface activation

Press and hold the ACTIVATE CONTROLS button on any Repeater until the green ACTIVATE CONTROLS LED turns OFF (approximately 3 seconds).

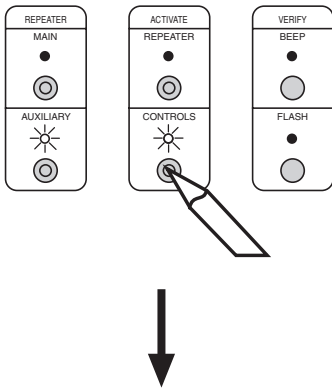

The green ACTIVATE CONTROLS LED on **ALL** Repeaters will turn OFF. The MAIN or AUXILIARY LED will remain on.

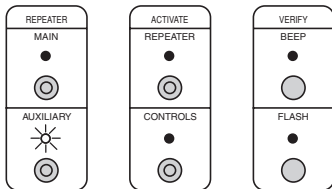

- The Switch Closure Input Interface is now activated.
- If you want to Verify that your Switch Closure Interface has been activated, see Flash Mode in the Troubleshooting Section on page 4-4.
- Proceed to Assigning a Dimmers, Switches or GRAFIK Eye® Control Units to Input Channels on page 3-7.

Adding a Switch Closure Interface

Assigning Dimmers, Switches or GRAFIK Eye® Control Units to Input Channels

Programming the Switch Closure Interface to control a light or a group of lights by a specified Input Channel.

Step 1 Begin assigning Dimmers, Switches or GRAFIK Eye® Control Units to Input Channels

Simultaneously press and hold the Program and Input Select buttons until the Program LED begins to flash (approximately 3 seconds).

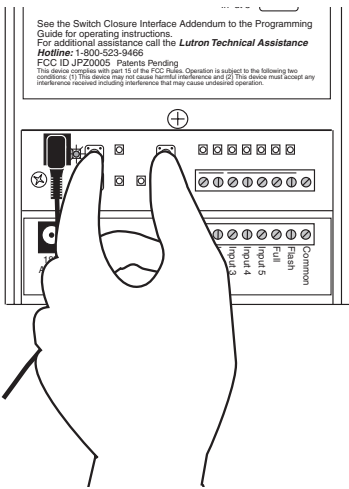

Program LED flashes. Input 1 LED and a Closure Type LED will turn ON.

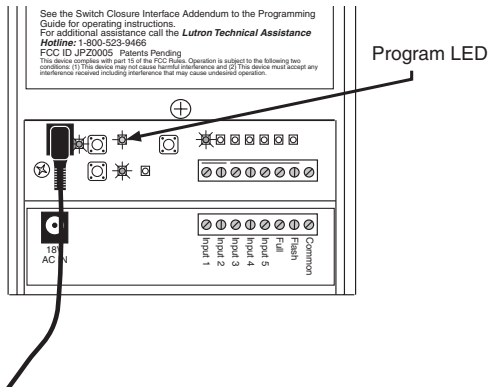

Step 2 Select an Input Channel to program

Press and release the Input Select button until the LED for the desired input channel turns ON.

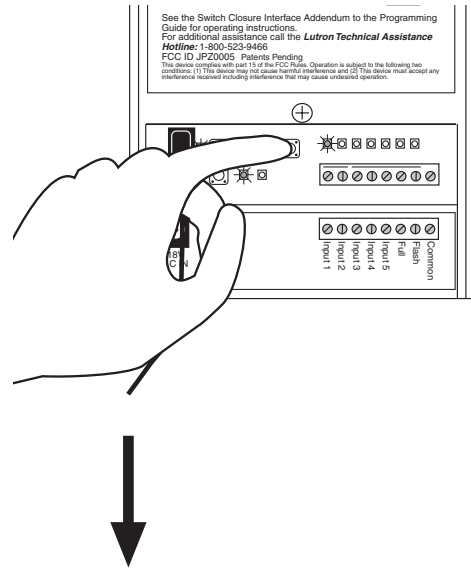

Selected Switch Closure Input Channel will have its LED ON.

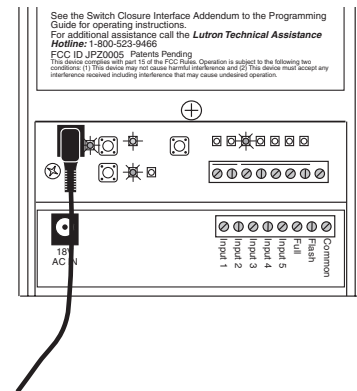

Adding a Switch Closure Interface

Step 3 Assign Dimmers, Switches or GRAFIK Eye® Control Units to Input Channel



In this Step you must not only assign light controls which you want to turn ON when the Input Channel is selected, you must also assign light controls which you want to turn OFF when the input channel is selected.

Assign a Dimmer or Switch to the selected Input Channel by turning the Dimmer or Switch ON.

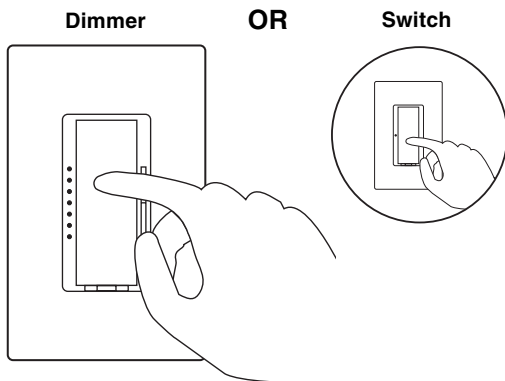

Assign a GRAFIK Eye® Control Unit to the selected Input Channel by changing the scene of the GRAFIK Eye® Control Unit.

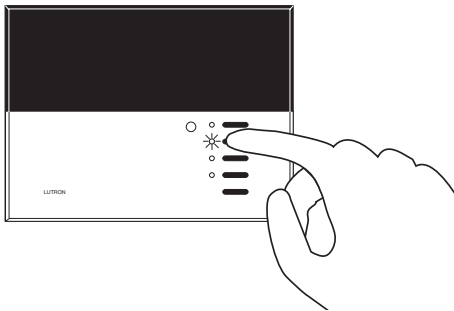

Note: GRAFIK Eye® Control Units will automatically turn ON to scene 1 once assigned.



If you assign the wrong Dimmer, Switch or GRAFIK Eye® Control Unit to a Input Channel, turn the Dimmer, Switch or GRAFIK Eye® Control Unit OFF to unassign it.



Step 4 Select Input Channel switch closure type

To assign an input channel switch closure type, press the Closure Type button to toggle between a Momentary and a Maintained input. **Note:** Momentary inputs must be closed for a minimum of 100 msec.

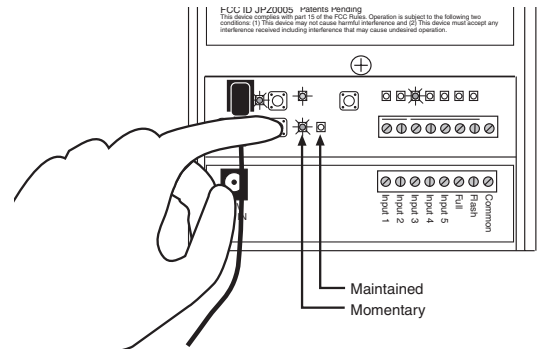

- Inputs 1 through 5 can be independently selected as Maintained or Momentary.
- Full and Flash are Maintained closures and cannot be changed.

Maintained Input Example

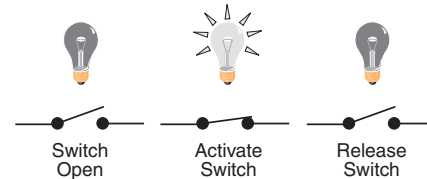

A Maintained switch closure will turn an input SCENE ON. Input SCENE remains ON until the switch closure is released. When released, the input SCENE returns to OFF..

Momentary Input Example

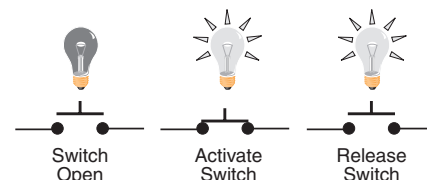

A Momentary switch closure will turn a SCENE ON. The input SCENE remains ON after the switch closure has been released, until the status of a Dimmer or Switch in that SCENE is changed.

• Continued on next page.

Adding a Switch Closure Interface

Step 5 Select next Input Channel to program

To assign Dimmers, Switches or GRAFIK Eye® Control Units to another Switch Closure Input Channel, press and release the Input Select button until that channel's LED turns ON.

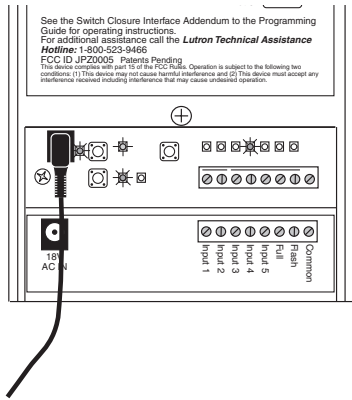
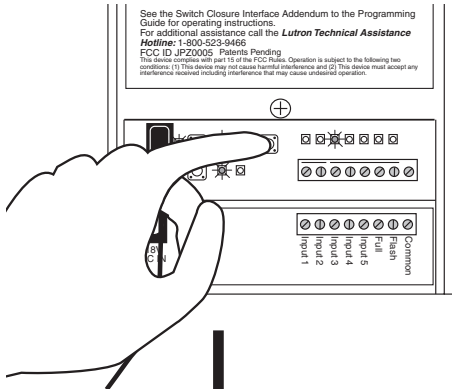

Perform Steps 3 and 4 for this newly selected Input Channel.

- Proceed to Step 6 when all Input Channels on the Switch Closure Interface have been programmed.

Step 6 Complete assigning Dimmers, Switches or GRAFIK Eye® Control Units to Input Channels

Press and hold the Program and Input Select buttons until the flashing Program LED turns OFF (approximately 3 seconds).

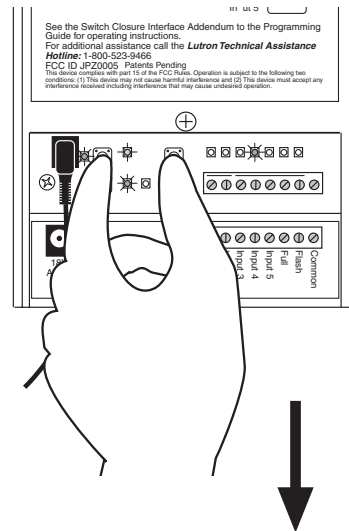

All Input LEDs will flutter for a few seconds when completing.

- Proceed to Setting Light Levels/GRAFIK Eye® Scene Selection on page 3-10.

Adding a Switch Closure Interface

Setting Light Levels/GRAFIK Eye® Scene Selection for Input Channels

Note: Dimmers can have a variable light level set or turned OFF. Switches can be turned ON or OFF. GRAFIK Eye® Control Units can be set to any scene or turned OFF.

Step 1 Begin setting light levels/ GRAFIK Eye® Scene Selection

Press and hold the Program button until the Program LED begins to blink (approximately 3 seconds).

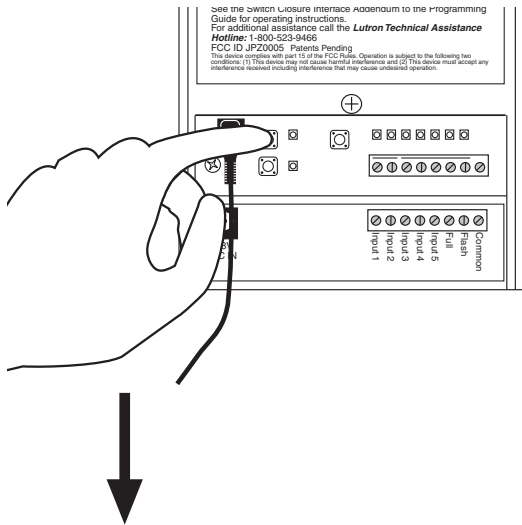

Program LED blinks. Input 1 LED and a Closure Type LED will turn ON.

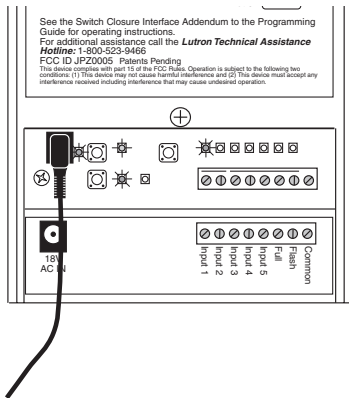

Dimmers assigned to Input 1 will turn ON to 50% light level. Switches assigned to Input 1 will turn ON. GRAFIK Eye® Control Units assigned to Input 1 will turn ON to scene 1. Dimmers, Switches or GRAFIK Eye® Control Units not assigned to Input 1 will turn OFF.

Note: Closure Type may not be changed while setting light levels.

Step 2 Select an Input Channel to program

Press and release the Input Select button until the LED for the desired input channel turns ON.

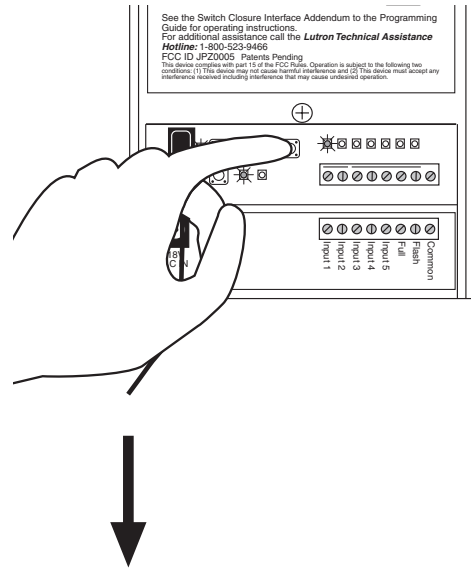

Selected Switch Closure Input Channel will have its LED ON.

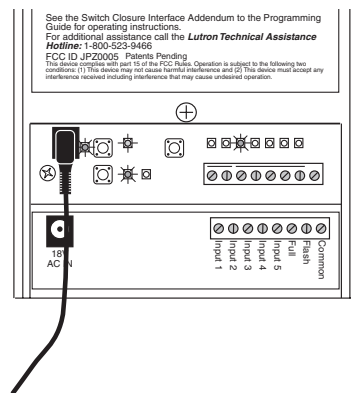

Note: Light levels cannot be set for FULL and FLASH dedicated security inputs. The default for these inputs is, Dimmers and Switches - ON at 100%, GRAFIK Eye® Control Units - ON to scene 1.

• **Continued on next page.**

Adding a Switch Closure Interface

Step 3 Set light levels/select GRAFIK Eye® scenes

Go to any **assigned** Dimmer (which will be ON at 50%). Adjust this Dimmers programmed light level for the selected SCENE button using the dimming rocker, **or** turn the Dimmer OFF if it is to be turned OFF when this Input Channel is activated.

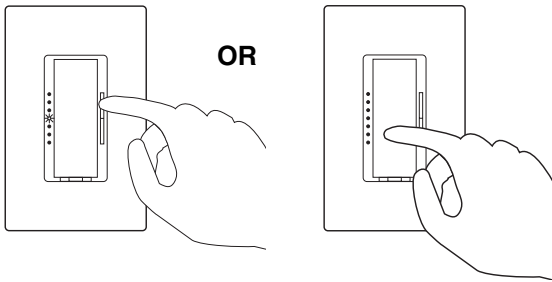

Adjust light levels

Turn OFF

Go to any **assigned** Switch (which will be ON). Turn the Switch OFF if it is to be turned OFF when this Input Channel is activated.

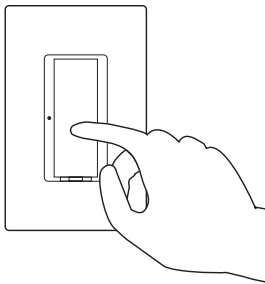

Go to any **assigned** GRAFIK Eye® Control Unit (which will be ON at scene 1). Select from pre-programmed scenes (1 through 4) by turning that scene ON **or** select OFF if it is to be turned OFF when this Input Channel is activated.

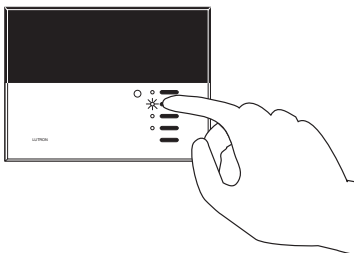

Step 4 Select next Input Channel to program

To set the light level for another Input Channel, press the Input Select button to turn that channel's LED ON.

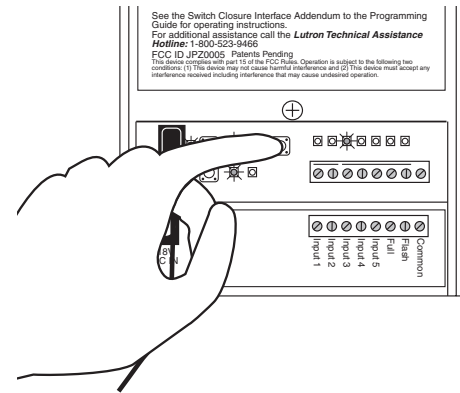

Selected Switch Closure Input Channel will have its LED ON.

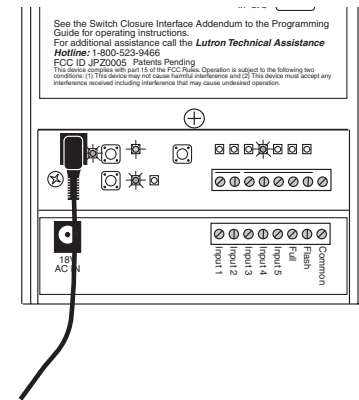

Adding a Switch Closure Interface

Step 5 Complete setting light levels/ GRAFIK Eye® Scene Selection

Press the Program button until the blinking Program LED turns OFF (approximately 3 seconds).

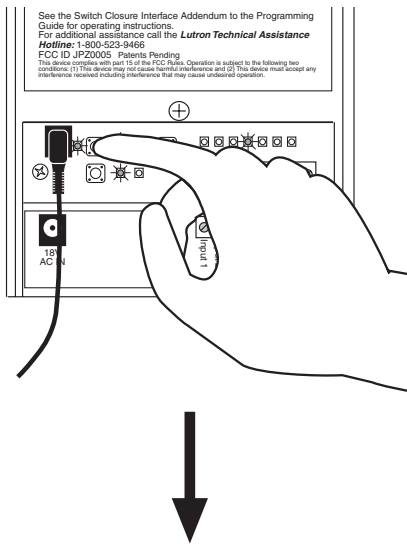

All Input LEDs will flutter for a few seconds when completing.

Troubleshooting Guide

Proper operation of the RadioRA® Wireless Central Home Lighting Control System is based upon a complex series of radio frequency (RF) communications between system components. As such, it is highly dependent upon proper system installation and programming of controls.

If you experience difficulties programming or operating your RadioRA® system, please refer to this guide. Many symptoms of common system activation or programming errors are contained in this Troubleshooting Guide. If you are having a problem with your system not described here, or if you have any questions, call the **Lutron Technical Support Center** at 1-800-523-9466.

	Symptom	Possible Cause	Remedy	Page
I	ACTIVATE REPEATER LED on MAIN or AUXILIARY Repeater turns orange when attempting to go into ACTIVATE REPEATER mode.	Your system has encountered a neighboring system within RF communication range also in ACTIVATE REPEATER mode.	Discontinue programming of your RadioRA® system until programming of the neighboring system is complete.	1-1
II	ACTIVATE REPEATER LED on a Repeater begins flashing orange.	The Repeater has been installed within RF communication range of a neighboring system, and has been assigned an identical house code.	If Repeater is a Main, cycle Repeater power and try again. If Repeater is an Auxiliary, return all System components to Default Factory Settings, then restart the system Activation Procedure.	1-1 4-5, 1-1
III	ACTIVATE REPEATER LED on an AUXILIARY Repeater begins alternately flashing green and orange.	The AUXILIARY Repeater is out of RF communication range of the MAIN Repeater.	Move the AUXILIARY Repeater to a new location in closer physical proximity to the MAIN Repeater.	
		The MAIN Repeater is not in ACTIVATE REPEATER mode.	Place MAIN Repeater in ACTIVATE REPEATER mode	1-1
IV	ACTIVATE CONTROLS LED on MAIN or AUXILIARY Repeater turns ON and then back OFF when attempting to go into ACTIVATE CONTROLS mode.	Your system has encountered a neighboring system within RF communication range also in ACTIVATE CONTROLS mode.	Discontinue activating your RadioRA® system until activation of the neighboring system is complete.	1-3
V	After activating a Dimmer, Switch or GRAFIK Eye® Control Unit, the control changes state, but does not flash the light(s) it controls.	Dimming or switching control is out of RF communication range of nearest system Repeater.	Move a system Repeater closer to the control in question, or you may have to add another Repeater.	
		System is not in ACTIVATE CONTROLS mode.	Place system in ACTIVATE CONTROLS mode.	1-3
VI	After activating a Master Control, the Master Control LEDs flutter for approximately 5 seconds then go out.	Master is out of RF communication range of nearest system Repeater.	Move a system Repeater closer to the Master Control in question, or vice versa, or you may have to add another Repeater.	
		System not in ACTIVATE CONTROLS mode.	Place system in ACTIVATE CONTROLS mode.	1-3
VII	A Tabletop Master Control or Switch Closure Interface appears not to be working at all.	No power available to unit.	Ensure that the plug on the rear of the unit is inserted fully and that the unit is plugged into a live wall receptacle. Check that the receptacle is not controlled by a switch. Check that breaker is on and not tripped.	
		Faulty power supply.	Swap power supplies with another Master Control or Repeater and check unit for power.	

Troubleshooting Guide

	Symptom	Possible Cause	Remedy	Page
VIII	A Dimmer, Switch or GRAFIK Eye® Control Unit appears not to be working at all.	Burned out or missing light bulb	Replace light bulb.	
		Front Accessible Service Switch (FASS™) is in the OFF position.	Turn FASS™ on (refer to operation guide included with the Dimmer or Switch).	
		No power available to unit.	Check that breaker is on and not tripped.	
		Unit has been wired incorrectly.	Refer to wiring instructions supplied with unit.	
IX	A Dimmer, Switch or GRAFIK Eye® Control Unit performs normally when operated manually, but fails to respond to Master Control button pushes.	The Dimmer, Switch or GRAFIK Eye® Control Unit may be out of RF communication range of the nearest Repeater.	Verify that the Dimmer, Switch or GRAFIK Eye® Control Unit is in range of a Repeater by placing the system in BEEP mode.	4-3
		The Dimmer, Switch, GRAFIK Eye® Control Unit or Master Control has been incorrectly activated.	Verify that each control has been activated correctly by placing the system into FLASH mode.	4-4
		Master Control was not programmed properly.	Reprogram Master Control.	1-7
		The Master Control may be out of RF communication range of the nearest Repeater.	Verify whether the Master Control is in range of a Repeater by placing the system in BEEP mode.	4-3
		A noise source (such as a motor or computer) is interfering with the RF communications.	Move the noise source away from the affected control (or vice versa if the control is a Tabletop Master). If it is not possible to move the noise source, move a Repeater closer to the affected control.	
		Poor power line frequency regulation (RadioRA® GRAFIK Interface).	Use a 24VAC transformer to power the GRAFIK Eye® Interface.	
		X	Dimmers, Switches or GRAFIK Eye® Control Units do not respond, or respond intermittently, to various master button pushes and no LEDs are lit on the nearest Repeater.	No power available to Repeater.
Repeater has faulty power supply.	Swap power supplies with another Repeater or Master Control and check unit for power. <i>If the repeater still appears to be inoperable after verifying that it has power, or all LEDs on the Repeater remain unlit after verifying it has power, please call the Lutron Technical Support Center.</i>			
XI	After attempting to activate a Switch Closure Interface, all Input LEDs flutter and then go out.	Switch Closure Input Interface is out of RF communication range of nearest system Repeater.	Move the Switch Closure Interface closer to a System Repeater.	
		System is not in ACTIVATE CONTROLS mode.	Place system in ACTIVATE CONTROLS mode.	3-5

BEEP Mode

BEEP Mode is used to verify that a Repeater can 'hear' a particular Control.

Step 1 Enter BEEP Mode

Press and hold the BEEP button on the Repeater you are checking until the green BEEP LED turns ON (approximately 3 seconds).

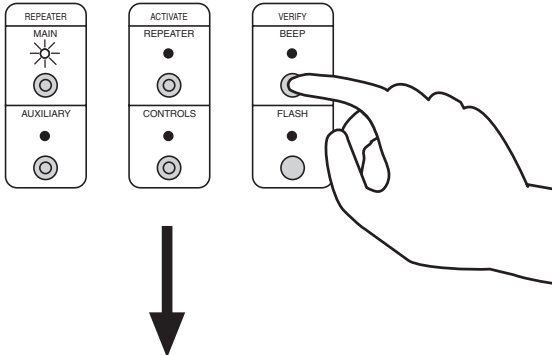

Green BEEP LED on that Repeater only will be ON.

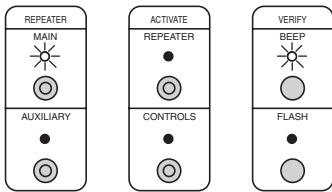

Step 2 Check a Control

Turn the Dimmer, Switch or GRAFIK Eye® Control Unit ON or OFF, press the ALL ON or ALL OFF button on a Master Control.

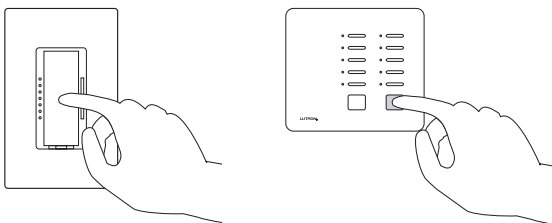

Step 3 Repeater response

If the Repeater can 'hear' the control, it will produce multiple audible beeps immediately after the button is pressed.

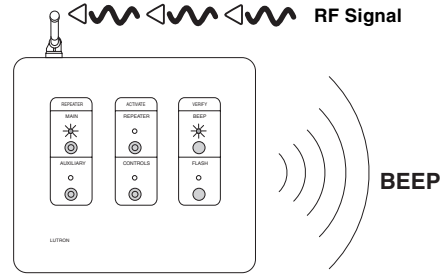

 If the Repeater does not beep, the Dimmer, Switch, GRAFIK Eye® Control Unit or Master Control is out of RF communication range of the Repeater. The Repeater must be moved closer to the control, or another Repeater must be added to the system.

Step 4 Exit BEEP Mode

Press and hold the BEEP button on the Repeater you are checking until the green BEEP LED turns OFF (approximately 3 seconds).

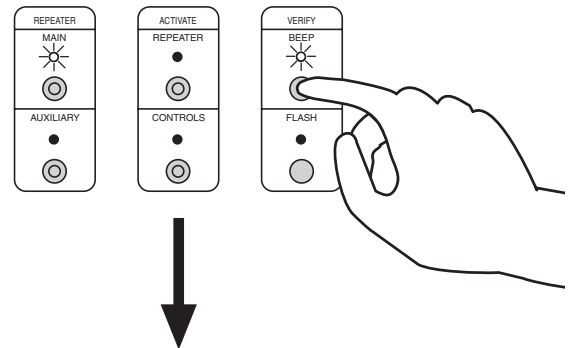

Green BEEP LED on that Repeater will go OFF. MAIN or AUXILIARY LED will stay ON.

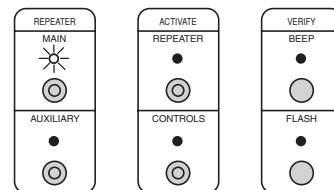

FLASH Mode

FLASH Mode is used to verify that a Control has been activated correctly.

Step 1 Enter FLASH Mode

Press and hold the FLASH button on any Repeater until the green FLASH LED turns ON (approximately 3 seconds).

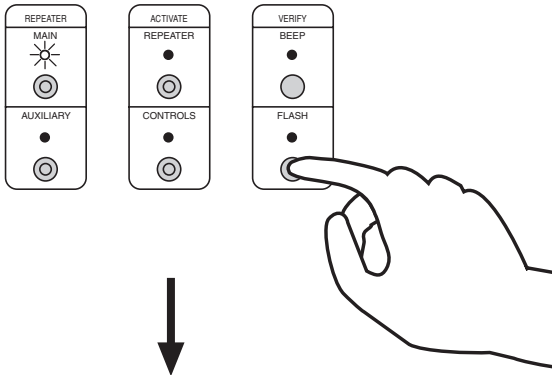

Green FLASH LED on all Repeaters will turn ON.

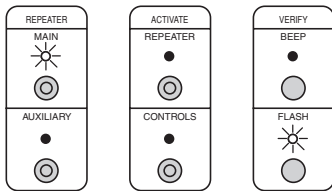

Step 2 Check all Controls

Master Controls and Switch Closure Interfaces, if activated, will flash all their LEDs. Make note of any Master Controls or Switch Closure Interfaces which are not activated.

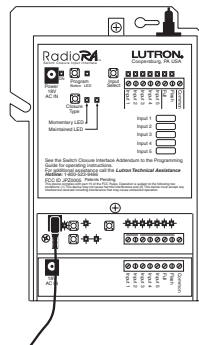
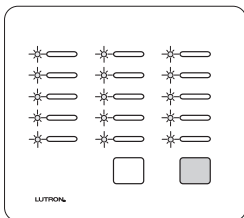

Dimmers, Switches, and GRAFIK Eye® Control Units, if activated, will flash the light(s) they control. Make note of any Dimmers, Switches or GRAFIK Eye® Control Units that are not activated.

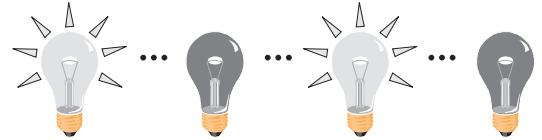

Step 3 Exit FLASH Mode

After checking all Controls, press and hold the FLASH button on any Repeater until the green FLASH LED turns OFF (approximately 3 seconds).

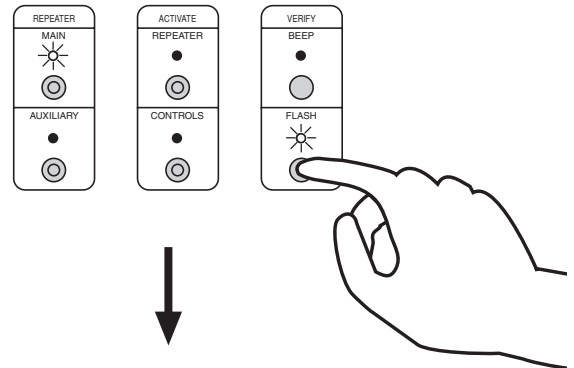

Green FLASH LED on all Repeaters will turn OFF.

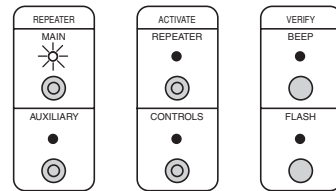

If any control has not been activated, see Adding Controls on page 3-3 or Adding a Switch Closure Interface on page 3-5.

Returning Components to Default Factory Settings

Master Controls

 Returning a Master Control to Default Factory Settings will permanently delete all current programming information. **Do not do this unless you are sure that it is necessary.** For more information call the *Lutron Technical Support Center.*

Step 1 Begin returning to Default Factory Settings

 Ensure that the ACTIVATE REPEATER LED or ACTIVATE CONTROLS LED on any Repeater is **NOT ON** before proceeding. If either LED is ON, press the corresponding button until it's LED turns OFF (approximately 3 seconds).

Press and hold the 1st, 3rd and 5th buttons in the right most column until the corresponding LEDs begin to flash (approximately 3 seconds).

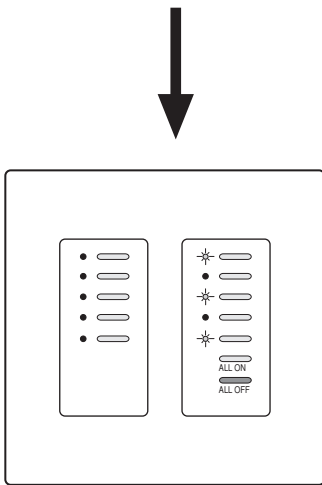
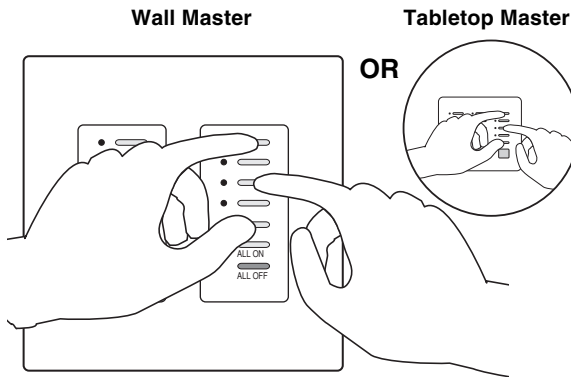

LEDs will flash for only 3 seconds.

Step 2 Complete returning to Default Factory Settings

While the 1st, 3rd, and 5th LED are flashing, press and hold the 2nd and 4th buttons in the right most column until all the LEDs flash.

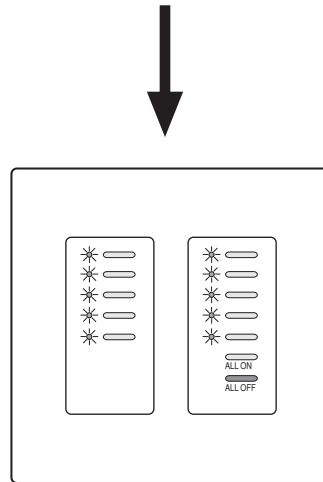
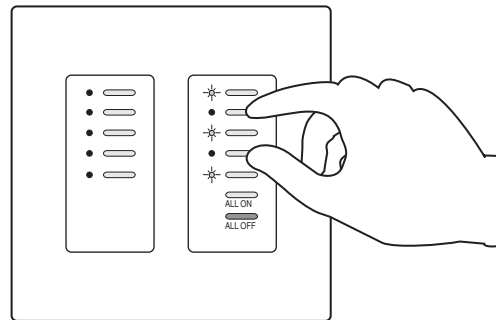

All LEDs will turn OFF, indicating that the Master Control has been returned to Default Factory Settings.

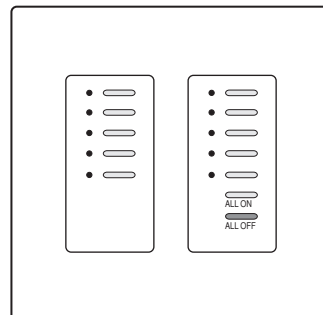

Returning Components to Default Factory Settings

Switch Closure Interface

 Returning a Switch Closure Interface to Default Factory Settings will permanently delete all current programming information. **Do not do this unless you are sure that it is necessary.** For more information call the **Lutron Technical Support Center**.

Step 1 Begin returning to Default Factory Settings

 Ensure that the **ACTIVATE REPEATER LED** or **ACTIVATE CONTROLS LED** on any Repeater is **NOT ON** before proceeding. If either LED is **ON**, press the corresponding button until its LED turns **OFF** (approximately 3 seconds).

Press and hold all three buttons until Input LEDs 1, 4, and Flash begin to flash (approximately 3 seconds).

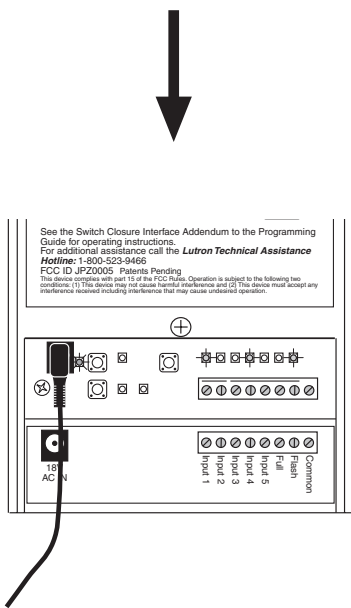
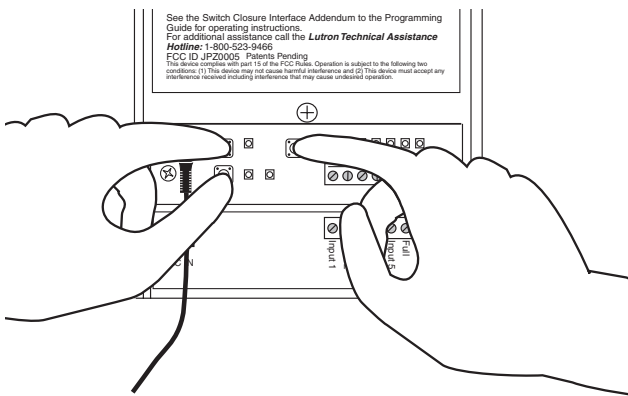

Step 2 Complete returning to Default Factory Settings

Press and hold the Program and Closure Type buttons until the Switch Closure Interface resets (all LEDs will flash).

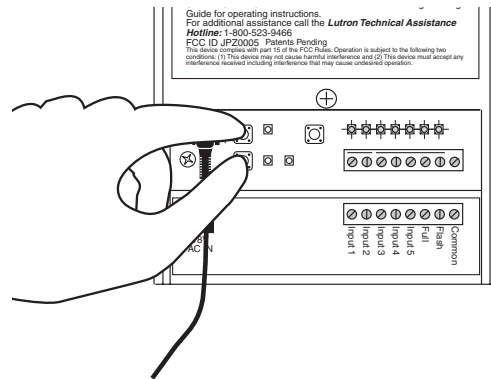

All LEDs (except the Power LED) will turn OFF indicating that the Switch Closure Interface has been returned to Default Factory Settings.

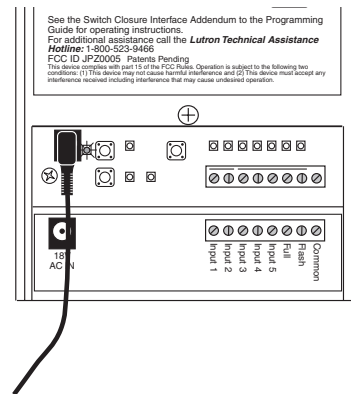

Returning Components to Default Factory Settings

Dimmers

 Returning a Dimmer to Default Factory Settings will permanently delete all current programming information. **Do not do this unless you are sure that it is necessary.** For more information call the *Lutron Technical Support Center.*

Step 1 Turn FASS™ switch OFF

 Ensure that the ACTIVATE REPEATER LED or ACTIVATE CONTROLS LED on any Repeater is **NOT ON** before proceeding. If either LED is ON, press the corresponding button until it's LED turns OFF (approximately 3 seconds).

Slide the Front Accessible Service Switch (FASS™) to the left.

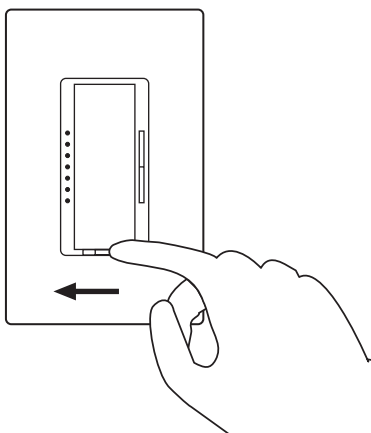

Step 2 Turn FASS™ switch back ON

Press and hold the raise rocker and the paddle switch while turning the FASS™ switch ON until the LEDs **begin to chase upward.**

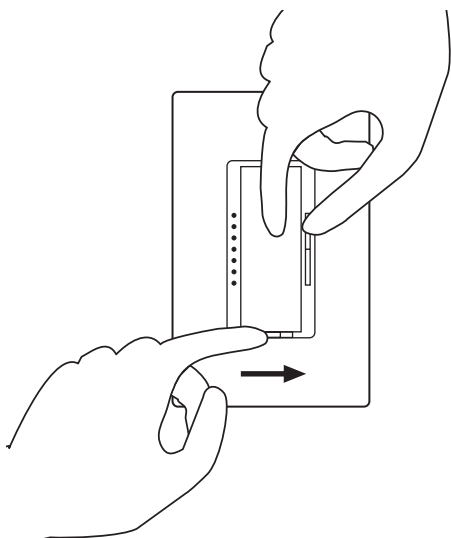

 If the LEDs chase downward, continue with Step 3, then repeat Steps 1-3 again.

Step 3 Return to Default Factory Settings

While the LEDs are chasing upward, simultaneously press and release the lower rocker and the paddle switch.

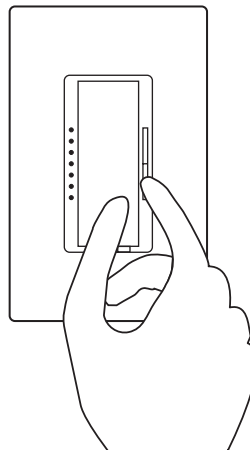

The light that the Dimmer controls will turn ON and OFF a few times indicating that the Dimmer has been returned to Default Factory Settings.

Returning Components to Default Factory Settings

Switches

 Returning a Switch to Default Factory Settings will permanently delete all current programming information. **Do not do this unless you are sure that it is necessary.** For more information call the **Lutron Technical Support Center**.

Step 1 Turn FASS™ switch OFF

 Ensure that the ACTIVATE REPEATER LED or ACTIVATE CONTROLS LED on any Repeater is **NOT ON** before proceeding. If either LED is ON, press the corresponding button until it's LED turns OFF (approximately 3 seconds).

Slide the Front Accessible Service Switch (FASS™) to the left.

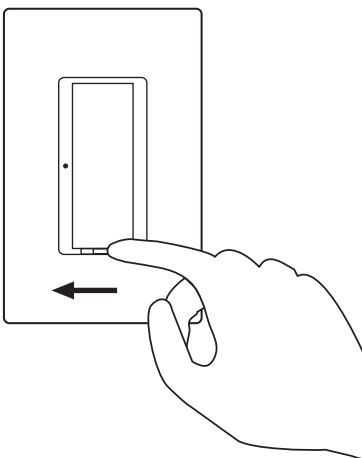

Step 2 Turn FASS™ switch back ON

Press and hold the paddle switch while turning the FASS™ switch ON until the LED begins to flash. The light the Switch controls will remain OFF.

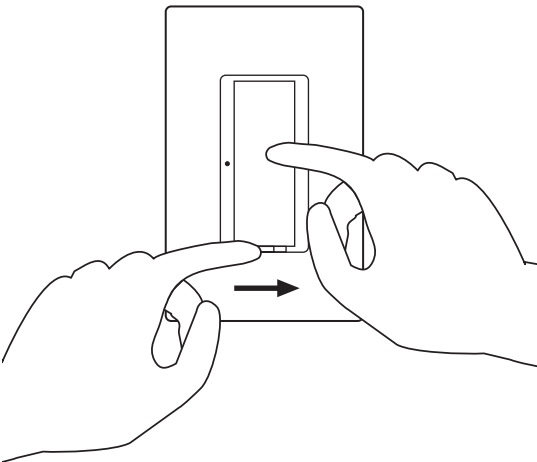

 If the LED **does not** flash, continue with Step 3, then repeat Steps 1-3 again.

Step 3 Return to Default Factory Settings

Release and then press and hold the paddle switch for 2 seconds.

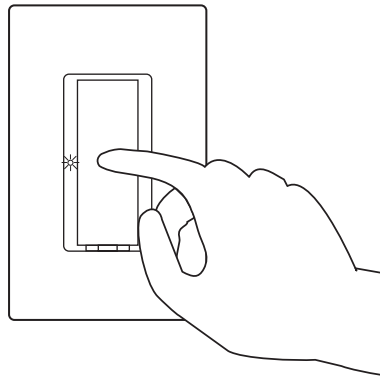

The light the Switch controls will turn ON and OFF a few times indicating that the Switch was returned to Default Factory Settings.

Returning Components to Default Factory Settings

GRAFIK Eye® Interface

 Returning a GRAFIK Eye® Interface to Default Factory Settings will permanently delete all current programming information. **Do not do this unless you are sure that it is necessary.** For more information call the *Lutron Technical Support Center*.

Step 1 Remove faceplate

 Ensure that the ACTIVATE REPEATER LED or ACTIVATE CONTROLS LED on any Repeater is **NOT ON** before proceeding. If either LED is ON, press the corresponding button until it's LED turns OFF (approximately 3 seconds).

Remove the faceplate from the GRAFIK Eye® Interface.

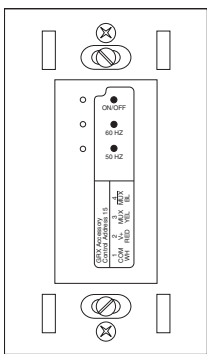

Step 2 Return to Default Factory Settings

Press and hold the ON/OFF button until the orange LED begins to blink (approximately 5 seconds).

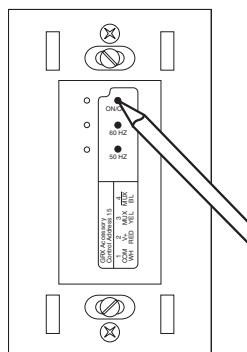

The GRAFIK Eye® Control Unit that was controlled by this GRAFIK Eye® Interface will turn ON and OFF a few times indicating that the interface has been returned to Default Factory Settings. Reattach the faceplate.

Returning Components to Default Factory Settings

Repeaters

 Returning a Repeater to Default Factory Settings will permanently delete all current programming information. **Do not do this unless you are sure that it is necessary.** Return all other devices in your system to Default Factory Settings before returning your Main Repeater to Default Factory Settings. For more information call the **Lutron Technical Support Center**.

Step 1 Begin returning to Default Factory Settings

 Ensure that the ACTIVATE REPEATER LED or ACTIVATE CONTROLS LED on any Repeater is **NOT ON** before proceeding. If either LED is ON, press the corresponding button until its LED turns OFF (approximately 3 seconds).

Press and **hold** (do not release) the BEEP button. The green BEEP LED will turn ON after approximately 3 seconds.

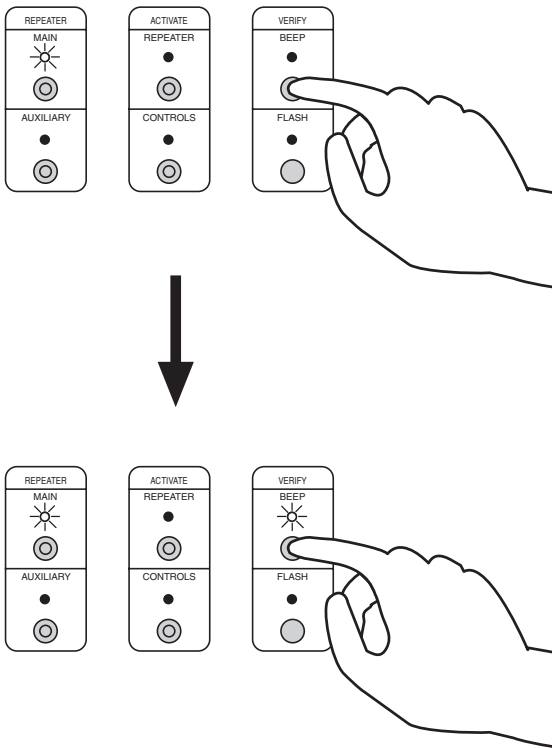

Step 2 Complete returning to Default Factory Settings

While holding the BEEP button, press and hold the ACTIVATE REPEATER button until the ACTIVATE REPEATER LED flashes alternately green and orange.

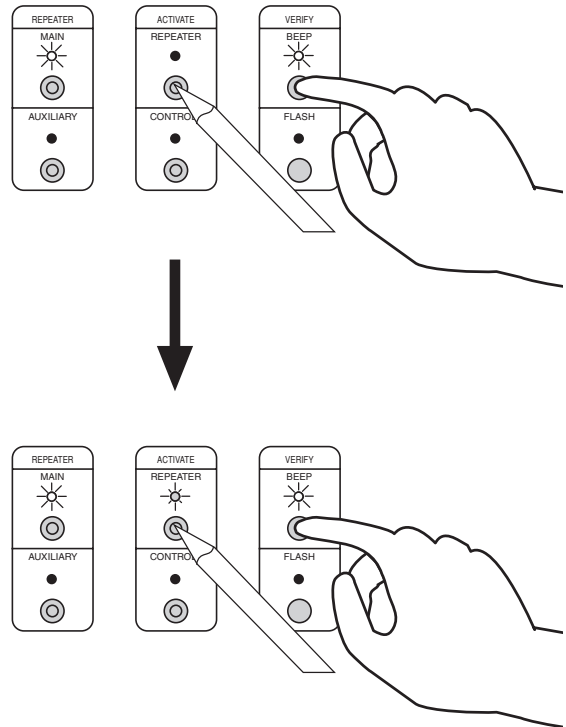

Release both buttons. All LEDs will flash once and only the AUXILIARY LED will stay ON, indicating that the Repeater has been returned to Default Factory Settings.

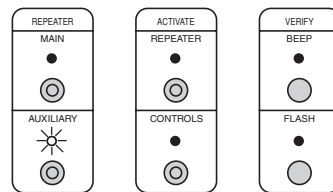

Using RadioRA® Master Controls with Raise/Lower

On Master Controls equipped with Raise/Lower buttons, you can remotely adjust the light levels of all the Dimmers, and GRAFIK Eye® Interfaces assigned to a particular Master Control button.

How Raise/Lower works

The Raise/Lower buttons affect a specific Master Control button. By default the upper right-hand button on the Master Control. As an example, if the Dimmer in the Kitchen were assigned to the upper right-hand button on the Master Control, pressing the Raise button would increase the light level of the Kitchen's Dimmer.

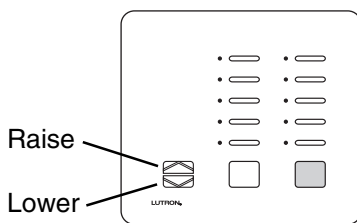

How to change which Dimmers you raise or lower

You can easily change which Master Control button is affected by the Raise/Lower button, quickly tap twice the Master Control button that you want to be affected by the Raise/Lower buttons. That Master Control button's LED will blink for about 2 seconds to indicate that the Raise/Lower buttons are now affecting that Master Control button.

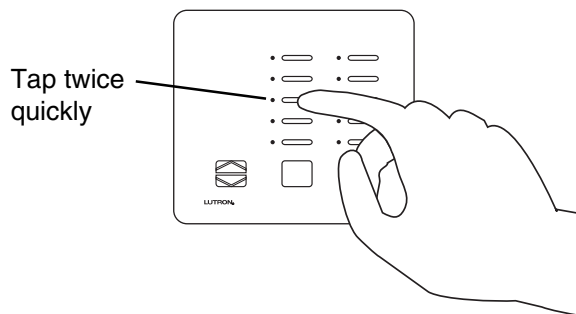

How LED status is affected

If you Raise a Dimmer that is initially OFF, the Dimmer will turn ON and increase its intensity to the desired level. Three seconds after the Raise button is released, the Dimmer's status will be broadcast to the entire system. Any Master Control ROOM LEDs, which have that Dimmer assigned to them, will turn ON since that Dimmer is now ON. Any Master Control SCENE LEDs, which have that Dimmer assigned to them, will turn OFF since the lights are no longer at their preset level for that SCENE.

System Functionality

The Raise/Lower buttons are designed to work with RadioRA® Dimmers and GRAFIK Eye® Interfaces only. RadioRA® Switches are not affected by Raise/Lower. Dimmers or GRAFIK Eye® Interfaces which have OFF as their preset level for a particular Scene will not be affected by Raise/Lower commands when the Raise/Lower buttons are affecting that Scene. Dimmers cannot be lowered to OFF.

Note: The functionality described above pertains to RadioRA® Dimmers and Switches which shipped after January 1, 2001 and GRAFIK Eye® Interfaces which shipped after February 1, 2001. Contact the Lutron Technical Support Center at 1-800-523-9466 for information on using Raise/Lower Master Controls with older dimming devices.

Limited Warranty

Lutron will, at its option, repair or replace any unit that is defective in materials or manufacture within one year after purchase. For warranty service, return unit to place of purchase or mail to Lutron Electronics Co., Inc. at 7200 Suter Rd., Coopersburg, PA 18036-1299, postage pre-paid.

THIS WARRANTY IS IN LIEU OF ALL OTHER EXPRESS WARRANTIES, AND THE IMPLIED WARRANTY OF MERCHANTABILITY IS LIMITED TO ONE YEAR FROM PURCHASE. THIS WARRANTY DOES NOT COVER THE COST OF INSTALLATION, REMOVAL OR REINSTALLATION, OR DAMAGE RESULTING FROM MISUSE, ABUSE, OR DAMAGE FROM IMPROPER WIRING OR INSTALLATION. THIS WARRANTY DOES NOT COVER INCIDENTAL OR CONSEQUENTIAL DAMAGES. LUTRON'S LIABILITY ON ANY CLAIM FOR DAMAGES ARISING OUT OF OR IN CONNECTION WITH THE MANUFACTURE, SALE, INSTALLATION, DELIVERY, OR USE OF THE UNIT SHALL NEVER EXCEED THE PURCHASE PRICE OF THE UNIT.

This warranty gives you specific legal rights, and you may have other rights which vary from state to state. Some states do not allow the exclusion or limitation of incidental or consequential damages, or limitation on how long an implied warranty may last, so the above limitations may not apply to you. This product may be covered under one or more of the following U.S. patents: 4,835,343; 4,954,768; 5,248,919; 5,399,940; 5,637,930; 5,736,965; 5,798,581; 5,838,226; 5,848,054; 5,905,442; 5,982,103; DES 353,798; DES 389,461; DES 389,805; DES 395,037; DES 404,013; DES 422,969, DES 428,855 and corresponding foreign patents. U.S. and foreign patents pending. Lutron, RadioRA, and GRAFIK Eye are registered trademarks, and FASS is a trademark of Lutron Electronics Co., Inc.

© 2000 Lutron Electronics Co., Inc.

World Headquarters

Lutron Electronics Co., Inc.

7200 Suter Road

Coopersburg, PA 18036-1299 U.S.A.

TOLL FREE: (800) 523-9466 (U.S.A., Canada, and the Caribbean)

Tel: (610) 282-3800

Fax: (610) 282-3090

Technical Assistance

If you have questions concerning the installation or operation of this product, call the **Lutron Technical Support Center**. Please provide exact model number when calling.

(800) 523-9466 (U.S.A., Canada, and the Caribbean)

Other countries call (610) 282-3800

Fax (610) 282-3090

Visit our web site at www.lutron.com

Lutron Electronics Co., Inc., reserves the right to make improvements or changes in its products without prior notice. Although every attempt is made to ensure that this information is accurate and up to date, please check with Lutron to confirm product availability, latest specifications and suitability for your application.